

**ATEQ G570**  
1.02 and 1.03 versions



(Photo non contractual)

**[www.ateq.com](http://www.ateq.com)**







# Recommendations for leak testing instruments

## Precautions for the test environment

- Keep the test area as clean as possible.

## Precautions for the operators

- **ATEQ** recommends that the operators using the instruments should have a suitable qualification and training with respect to the work bench requirements.

## General precautions

- Read the user manual before using the instrument,
- all electrical connections to the instrument must be equipped with a safety system (fuse, circuit breaker...) appropriate to its needs and complying with the standards,
- to avoid electromagnetic interference, the cable connections to the instrument should be less than two meters in length,
- it is essential that the electrical main is earthed,
- disconnect the electrical connections to the equipment before maintenance,
- cut the air supply for any kinds of operation on the pneumatic assembly,
- do not open the instrument when it is powered up,
- avoid water spillage near of the instrument,
- **ATEQ** is at your disposal for any further information concerning the use of the instrument under maximum safety conditions.



**We would like to bring to your attention that ATEQ will not be held responsible for any accident connected to the improper use of the instrument, to the work bench or to the lack of compliance with safety rules.**

**ATEQ Company is free from any responsibility for any adjustment of its instrument which would not have been done by its own technicians.**



## **ATEQ, THE ASSURANCE OF A COMPETENT AFTER SALES SERVICE**

### **■ THE ATEQ AFTER SALES SERVICE IS :**

- a team of qualified technicians,
- a permanent telephone assistance,
- agencies close to you for faster reaction,
- a stock of spare parts available immediately,
- a car fleet for rapid intervention,
- a commitment to quality ...

### **■ THE OVERHAUL**

ATEQ carries out the overhaul of your instruments at interesting prices.

The overhaul corresponds to the maintenance of the instrument (checking, cleaning, replacing of used parts) as part of preventive maintenance.

Preventive maintenance is the best way to guarantee reliability and efficiency. It allows the maintenance of a group of instruments in good operational order and prevent eventual break-downs.

### **■ MAINTENANCE KITS**

The ATEQ After Sales Service proposes, two kits destined for the preventive maintenance of the pneumatic circuits of instruments.

### **■ CALIBRATION**

This may be carried out on site or in our offices.

ATEQ is attached to the COFRAC and delivers a certificate following a calibration.

### **■ TRAINING COURSES**

In the framework of partnership with our customers, ATEQ offers two types of training in order to optimise the usage and knowledge of our instruments. They are aimed at different levels of technician:

- method / control training,
- maintenance / upkeep training.

### **■ A TARGETED TECHNICAL DOCUMENTATION**

A number of technical documents are at your disposal to allow you to intervene rapidly in the event minor breakdowns:

- problem sheets describing and offering solutions to the main pneumatic and electronic problems,
- several maintenance manuals.

### **■ A QUALITY GUARANTEE**

The instruments are guaranteed for parts and labour in our offices:

- 2 years for leak detection equipment,
- 1 year for electrical tests to norms instruments,
- 1 year for the accessories.

Our After Sales Service is capable of rapidly answering all your needs and queries.

**ATEQ recommends  
to made realise by its departments  
a revision and a calibration of the instruments  
every year**



## PREFACE

Dear Customer,

You have just purchased an **ATEQ** instrument, we thank you for the trust you have placed on our brand. This instrument has been designed to ensure a long and unparalleled life expectancy, and we are convinced that it will give you complete satisfaction during many long years of operation.

In order to maximise the life expectancy and reliability of your **ATEQ** instrument, we recommend that you install this instrument on a secured workbench and advise you to consult this manual in order to familiarise yourself with the functions and capabilities of the instrument.

Our **ATEQ** After Sales Service centre can give you recommendations based on your specific operation requirements.

**ATEQ**



---

**TABLE OF CONTENTS**

---

**Preamble** **DEFINITION AND PRINCIPLES OF THE G570**

|                                             |          |
|---------------------------------------------|----------|
| <b>1. DEFINITION</b> .....                  | <b>5</b> |
| <b>2. CHARACTERISTICS MEASUREMENT</b> ..... | <b>6</b> |
| 2.1. Flow measurement.....                  | 6        |
| 2.2. Pressure measurement.....              | 6        |
| 2.3. Mechanical pressure regulation .....   | 6        |
| <b>3. OPERATIONAL CHARACTERISTICS</b> ..... | <b>7</b> |
| <b>4. PRESENTATION OF THE SYMBOLS</b> ..... | <b>8</b> |

**Chapter 1** **INSTALLATION OF THE INSTRUMENT**

|                                                             |           |
|-------------------------------------------------------------|-----------|
| <b>1. APPEARANCE OF THE ATEQ G570</b> .....                 | <b>11</b> |
| <b>2. LAYOUT OF CONNECTORS ON THE G570 REAR PANEL</b> ..... | <b>11</b> |
| <b>3. CONNECTOR DETAILS</b> .....                           | <b>12</b> |
| 3.1. Electric connectors .....                              | 12        |
| 3.2. Pneumatic connectors.....                              | 18        |
| 3.3. Pneumatic supply .....                                 | 19        |

**Chapter 2** **USER INTERFACES**

|                                                   |           |
|---------------------------------------------------|-----------|
| <b>1. ATEQ G520 FRONT PANEL APPEARANCE</b> .....  | <b>21</b> |
| <b>2. APPEARANCE OF THE KEYBOARD</b> .....        | <b>22</b> |
| 2.1. Navigation keys .....                        | 22        |
| 2.2. Cycle keys .....                             | 22        |
| <b>3. LOCKABLE SWITCH</b> .....                   | <b>23</b> |
| <b>4. 4 LINE LCD DISPLAY</b> .....                | <b>23</b> |
| <b>5. 14 CHARACTER LED DISPLAY</b> .....          | <b>23</b> |
| <b>6. QUICK CONNECTOR</b> .....                   | <b>23</b> |
| <b>7. INFRA-RED INTERFACE</b> .....               | <b>24</b> |
| <b>8. FUNCTIONS OF THE INDICATOR LIGHTS</b> ..... | <b>24</b> |

**Chapter 3** **INSTALLATION AND SETTINGS**

|                                                      |           |
|------------------------------------------------------|-----------|
| <b>1. POWERING UP THE ATEQ G570</b> .....            | <b>25</b> |
| <b>2. CREATION OF A TEST PROGRAM</b> .....           | <b>25</b> |
| 2.1. Choice of the program number .....              | 26        |
| 2.2. Test type selection .....                       | 26        |
| 2.3. Parameter settings .....                        | 27        |
| <b>3. DUPLICATION OF A TEST PROGRAM</b> .....        | <b>32</b> |
| <b>4. DELETING A PROGRAM OR A PROGRAM NAME</b> ..... | <b>33</b> |
| <b>5. CHOICE OF THE PROGRAM TO BE RUN</b> .....      | <b>34</b> |
| <b>6. STARTING A MEASUREMENT CYCLE</b> .....         | <b>34</b> |
| <b>7. STOPPING A CYCLE</b> .....                     | <b>34</b> |

| <b>Chapter 4</b>                                         | <b>FUNCTIONS OF THE INSTRUMENT</b> |
|----------------------------------------------------------|------------------------------------|
| <b>1. MENU STRUCTURE.....</b>                            | <b>35</b>                          |
| 1.1. Main menu.....                                      | 35                                 |
| 1.2. "FUNCTIONS" menu when activated.....                | 39                                 |
| <b>2. CONFIGURATION MENU .....</b>                       | <b>41</b>                          |
| 2.1. Extended menus .....                                | 41                                 |
| 2.2. Automatic save.....                                 | 54                                 |
| 2.3. Piezo auto zero .....                               | 54                                 |
| 2.4. Bar Graph.....                                      | 55                                 |
| 2.5. Hour.....                                           | 55                                 |
| 2.6. RS232 .....                                         | 55                                 |
| 2.7. RS485 .....                                         | 60                                 |
| 2.8. Security .....                                      | 60                                 |
| 2.9. Lighting the screen.....                            | 60                                 |
| 2.10. External dump option .....                         | 61                                 |
| 2.11. Shut off (option).....                             | 62                                 |
| 2.12. Negative flow alarm.....                           | 63                                 |
| 2.13. I/O configuration.....                             | 63                                 |
| <b>3. SPECIAL CYCLES MENU.....</b>                       | <b>64</b>                          |
| 3.1. Special cycles available .....                      | 64                                 |
| 3.2. Volume calculation .....                            | 65                                 |
| 3.3. Infinite fill .....                                 | 66                                 |
| 3.4. Piezo auto zero .....                               | 67                                 |
| 3.5. Print .....                                         | 68                                 |
| 3.6. Atmospheric conditions .....                        | 68                                 |
| <b>4. SERVICE MENU .....</b>                             | <b>69</b>                          |
| 4.1. Parameters service .....                            | 69                                 |
| 4.2. Servicing of the sensors.....                       | 70                                 |
| <b>5. RESULTS MENU .....</b>                             | <b>71</b>                          |
| <b>6. LANGUAGE MENU .....</b>                            | <b>71</b>                          |
| <b>7. STAND BY MENU .....</b>                            | <b>71</b>                          |
| 7.1. Standby using the menu .....                        | 72                                 |
| <hr/>                                                    |                                    |
| <b>Chapter 5</b>                                         | <b>ACCESSORIES</b>                 |
| <b>1. ACCESSORIES SUPPLIED WITH THE INSTRUMENT .....</b> | <b>73</b>                          |
| 1.1. Mains power cable (supplied with the G570).....     | 73                                 |
| <b>2. OPTIONAL ACCESSORIES.....</b>                      | <b>74</b>                          |
| 2.1. Calibrated leak .....                               | 74                                 |
| 2.2. Needle valve and Leak/Flow Calibrator (CDF) .....   | 75                                 |
| 2.3. Automatic connectors with expandable joints .....   | 76                                 |
| 2.4. Filtration kit.....                                 | 76                                 |
| 2.5. Simple remote control .....                         | 77                                 |
| 2.6. External shut off valve option.....                 | 78                                 |
| 2.7. External dump valve and shut off function.....      | 78                                 |
| <hr/>                                                    |                                    |
| <b>Chapter 6</b>                                         | <b>ERROR MESSAGES</b>              |
| <b>ERROR MESSAGES .....</b>                              | <b>79</b>                          |

|                                                                    |                             |
|--------------------------------------------------------------------|-----------------------------|
| <b>Chapter 7</b>                                                   | <b>OPERATIONAL PROBLEMS</b> |
| 1. PHENOMENON NOTED.....                                           | 81                          |
| 1.1. Condition of the machine's seals .....                        | 81                          |
| 1.2. Damaged instrument seals .....                                | 81                          |
| 1.3. Bumper pad.....                                               | 81                          |
| 1.4. Pneumatic air supply too low .....                            | 81                          |
| 1.5. Pneumatic Link.....                                           | 81                          |
| 1.6. Environment .....                                             | 82                          |
| 1.7. Calibration .....                                             | 82                          |
| 1.8. Concerns about reliability of the instrument's circuits ..... | 82                          |
| <b>Appendices</b>                                                  | <b>ATEQ G570</b>            |
| 1. TECHNICAL CHARACTERISTICS OF THE G570 .....                     | 83                          |
| 2. MECHANICAL DEFINITION DRAWINGS OF G570.....                     | 84                          |
| 3. CONVERSION TABLE .....                                          | 85                          |
| 4. PARAMETERS STORED .....                                         | 86                          |
| 5. VALVES CODES USED IN YOUR APPLICATION .....                     | 87                          |
| 6. USER NOTES .....                                                | 88                          |
| <b>Index</b>                                                       | <b>89</b>                   |



## Preamble

# DEFINITION AND PRINCIPLES OF THE G570

## 1. DEFINITION

The **ATEQ G570** is the latest air/air leak detector operating on a continuous basis (automatic test start).

The instrument has been designed to test low pressure components and assemblies (less than 500 mbar) and more particularly gas applications in compliance with European standards, but it can also work with high pressure.

The use of continuous testing may allow the localisation and repair of leaks.

The instrument may also operate in "controlled" mode, a mode which is advantageous for certain applications, with pre-fill or rapid fill or on automatic workbenches.

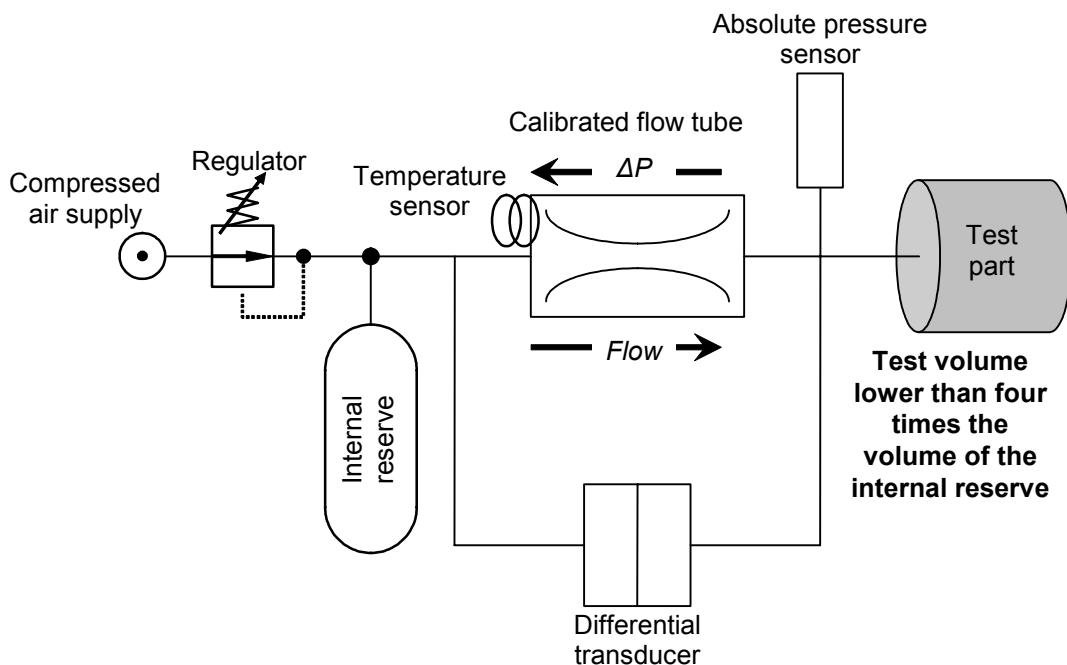

The **ATEQ G570** includes:

a pneumatic assembly allowing:

- the pressurisation of the test part and the reserve through the use of a regulator,
- the measurement of the leak flow image with a differential transducer placed on the end of a calibrated flow tube,
- the monitoring of the test pressure with a piezo sensor acting as a pressure controller,
- the temperature measurement of the calibrated flow tube to correct the measured flow,

a programmable electronic board allowing:

- the saving of all the cycle adjustments,
- the calculation, display and transmission of the test results.

## 2. CHARACTERISTICS MEASUREMENT

### 2.1. FLOW MEASUREMENT

| RANGE                       | ACCURACY                          | Maximum RESOLUTION         |
|-----------------------------|-----------------------------------|----------------------------|
| 100 cm <sup>3</sup> .atm/h  | +/- (3,5% of the flow + 0,5 ml/h) | 0,1 cm <sup>3</sup> .atm/h |
| 1000 cm <sup>3</sup> .atm/h | +/- (3,5% of the flow + 5 ml/h)   | 1 cm <sup>3</sup> .atm/h   |

### 2.2. PRESSURE MEASUREMENT

The characteristics are common for all the 5<sup>th</sup> series instruments.

| RANGE                                                 | ACCURACY                             | Maximum RESOLUTION |
|-------------------------------------------------------|--------------------------------------|--------------------|
| <b>F. S. = 7,5 kPa*</b><br>(F. S. = 75 mbar*)         | +/- (1,5% of the pressure + 0,2 hPa) | 0,1 % F. S.        |
| <b>F. S. &lt; 30 kPa</b><br>(F. S. < 0,3 bar)         | +/- (1,5% of the pressure + 1 hPa)   | 0,1 % F. S.        |
| <b>30 ≤ F. S. ≤ 100 kPa</b><br>(0,3 ≤ F. S. ≤ 1 bar)  | +/- (1,5% of the pressure + 3 hPa)   | 0,1 % F. S.        |
| <b>100 ≤ F. S. ≤ 1000 kPa</b><br>(1 < F. S. ≤ 10 bar) | +/- (1,5% of the pressure + 7.5 hPa) | 0,1 % F. S.        |

\* Specific (relative)

| G 5 <sup>th</sup> series pressure range |              |
|-----------------------------------------|--------------|
| 5 – 50 kPa                              | 50 – 400 kPa |

### 2.3. MECHANICAL PRESSURE REGULATION

5 kPa to 50 kPa / 50 kPa to 400 kPa

### **3. OPERATIONAL CHARACTERISTICS**



The **ATEQ G570** carries out a pressure measurement on the ends of calibrated flow tubes connecting the test part and the internal instrument reference part (reserve) which have been previously equalised at the same pressure.



The measurement is displayed in ml/minute or in ml/hour returned to atmospheric pressure.

The flow measurement is dependant on a certain number of parameters: test pressure, the volume of the part to be tested, the volume of the reference. Additionally, it is necessary to optimise a number of adjustments (timings). We have strived towards the production of a user friendly instrument, that is why a few adjustments are not accessible to the operator. These are set in the factory depending on a customers' required specifications.

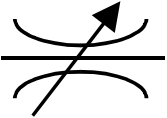
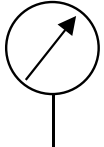
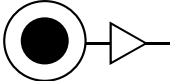
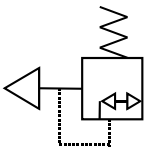
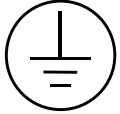
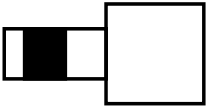
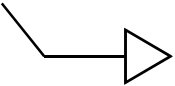
It's also possible to work in standard conditions mode.

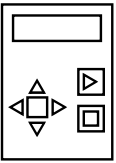
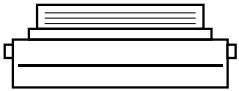
#### 4. PRESENTATION OF THE SYMBOLS

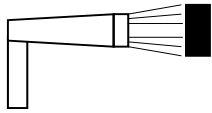
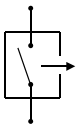
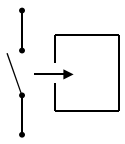
| Symbol                                                                              | Name                  | Function                                                                                                                                          |
|-------------------------------------------------------------------------------------|-----------------------|---------------------------------------------------------------------------------------------------------------------------------------------------|
|    | Adjust leak connector | Pneumatic connector for the plugging of a calibrated leak (ruby kind) or an adjustable leak.                                                      |
|    | Pressure connector    | Pneumatic connector for the plugging of a manometer for an external checking of the pressure.                                                     |
|    | Pressure supply       | of the air supply from the 6 bar network.                                                                                                         |
|    | Test circuit supply   | Pneumatic connector (according to option) for the plugging of a supplementary pneumatic supply, used in case of test pressure greater than 8 bar. |
|  | Ground connector      | Connector for the electric plugging to the ground.                                                                                                |
|  | Automatic connector   | Pneumatic connector for the driving of an external logic or pneumatic components (pneumatic sealing connector).                                   |
|  | Connector             | Connector for pneumatic output.                                                                                                                   |
|  | Connector             | Connector for pneumatic input.                                                                                                                    |
|  | Warning!              | Read and respect the instructions of the user manual, before plugging and using the instrument.                                                   |
|  | Remote control        | Connector for a remote control.                                                                                                                   |
|  | Printer               | Connector for printer plugging.                                                                                                                   |

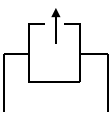
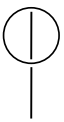
| Symbol                                                                             | Name            | Function                                                                                |
|------------------------------------------------------------------------------------|-----------------|-----------------------------------------------------------------------------------------|
|   | Bar code reader | Connector for bar code reader plugging.                                                 |
|   | Output          | Dry contact output.                                                                     |
|   | Input           | Dry contact input.                                                                      |
|   | Infrared link   | Infrared link, at this place there's the receiver and transmitter of the infrared link. |
|   | Analogue output | Analogue output.                                                                        |
|  | Analogue input  | Analogue input for the temperature sensor.                                              |



## Chapter 1

# INSTALLATION OF THE INSTRUMENT

### 1. APPEARANCE OF THE ATEQ G570

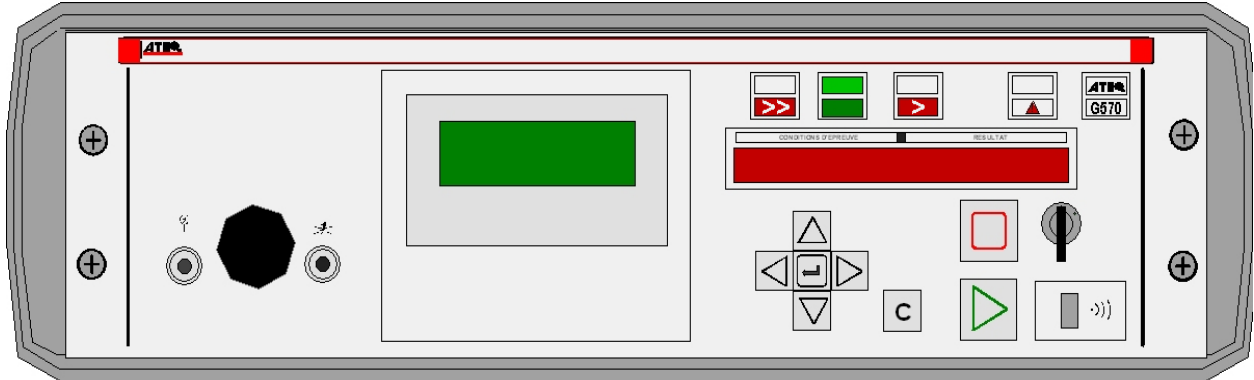

The **ATEQ G570** comes in a 19" inch format casing.

The instrument is delivered with a 110/220 V power supply cable.

### 2. LAYOUT OF CONNECTORS ON THE G570 REAR PANEL

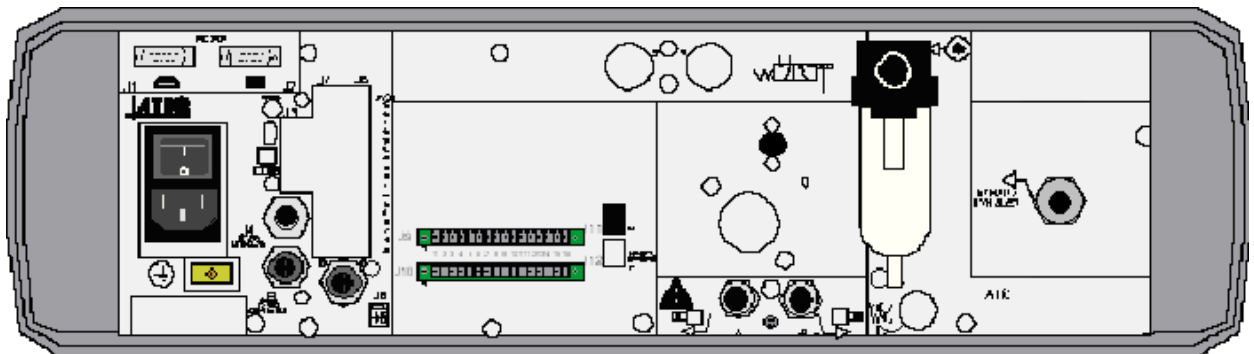

### 3. CONNECTOR DETAILS

#### 3.1. ELECTRIC CONNECTORS

##### 3.1.1. ON/Off switch

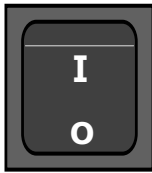

I: ON  
O: OFF

##### 3.1.2. Power supply



From 90 to 260 V AC / 50 W

##### 3.1.3. J1 connector (RS232)

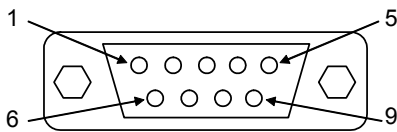

Used for connection of a printer, a bar-code reader, a PC or a memory module.

9 pins SubD male base connector.

|       |                    |       |                     |
|-------|--------------------|-------|---------------------|
| PIN 1 | Not used           | PIN 6 | 5 V DC ATEQ use     |
| PIN 2 | RXD Data reception | PIN 7 | RTS request to send |
| PIN 3 | TXD Data emission  | PIN 8 | CTS clear to send   |
| PIN 4 | Not used           | PIN 9 | Not used            |
| PIN 5 | Earth / Ground     |       |                     |

##### 3.1.4. J2 connector (RS232)

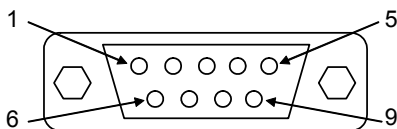

Allows the connection of a bar code reader.

9 pins SubD male base connector.

|       |                    |       |                     |
|-------|--------------------|-------|---------------------|
| PIN 1 | Not used           | PIN 6 | 5 V DC ATEQ use     |
| PIN 2 | RXD Data reception | PIN 7 | RTS request to send |
| PIN 3 | TXD Data emission  | PIN 8 | CTS clear to send   |
| PIN 4 | Not used           | PIN 9 | Not used            |
| PIN 5 | Earth / Ground     |       |                     |

3.1.4. 1) Examples of RS232 cables

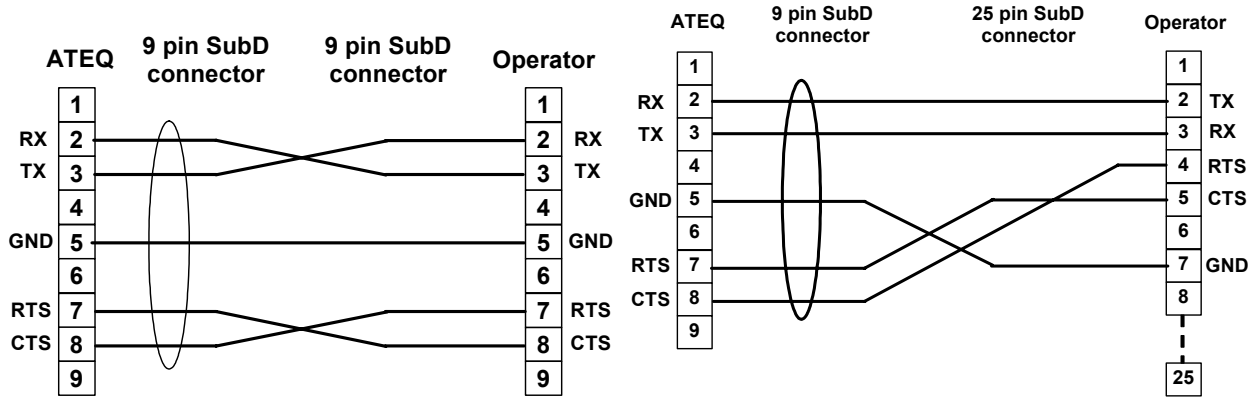

3.1.5. J3 connector

Not used

3.1.6. J4 input connector (RS485)

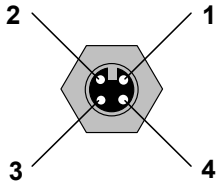

**ATEQ** reserved network.  
Allows the connection to other **ATEQ** instruments.  
(Male Lumberg type connector).

|       |                |       |                   |
|-------|----------------|-------|-------------------|
| PIN 1 | Network data + | PIN 3 | Network data -    |
| PIN 2 | Power +24V     | PIN 4 | Ground / Earth 0V |

3.1.7. J5 output connector (RS485)

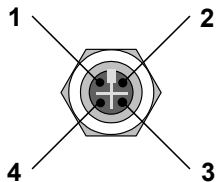

**ATEQ** reserved network.  
Allows the connection to other **ATEQ** instruments.  
(Female Lumberg type connector).

|       |                |       |                   |
|-------|----------------|-------|-------------------|
| PIN 1 | Network data + | PIN 3 | Network data -    |
| PIN 2 | Power +24V     | PIN 4 | Ground / Earth 0V |

3.1.8. J6 connector RS232 (remote control)

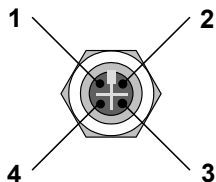

Allows the connection of an intelligent remote control.  
(Female Lumberg type connector).

|       |             |       |                   |
|-------|-------------|-------|-------------------|
| PIN 1 | Network TXD | PIN 3 | Network RXD       |
| PIN 2 | Power +24V  | PIN 4 | Ground / Earth 0V |

3.1.9. J9 connector (outputs codes / analogue outputs / temperature sensors)

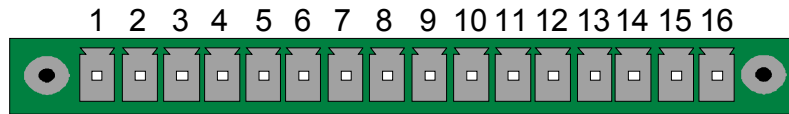

|        |                            |                                             |
|--------|----------------------------|---------------------------------------------|
|        | COMMON (Outputs 1,2,3)     | OUTPUT CODES<br>24V DC 100mA Max<br>Outputs |
| PIN 2  | Output n°1                 |                                             |
| PIN 3  | Output n°2                 |                                             |
| PIN 4  | Output n°3                 |                                             |
| PIN 5  | COMMON (Outputs 4,5,6)     |                                             |
| PIN 6  | Output n°4                 |                                             |
| PIN 7  | Output n°5                 | TEMPERATURE<br>SENSORS                      |
| PIN 8  | Output n°6                 |                                             |
| PIN 9  | 12V Sensor power supply    |                                             |
| PIN 10 | 0V Sensor power supply     | ANALOGUE<br>OUTPUTS                         |
| PIN 11 | Sensor n°1 Input           |                                             |
| PIN 12 | Sensor n°2 Input           |                                             |
| PIN 13 | Analogue output n°1        |                                             |
| PIN 14 | COMMON (Analogue output 1) |                                             |
| PIN 15 | Analogue output n°2        |                                             |
| PIN 16 | COMMON (Analogue output 2) |                                             |

The analogue outputs are the rough signals: 4 – 20 mA or 0 – 10 V depending on the chosen option.

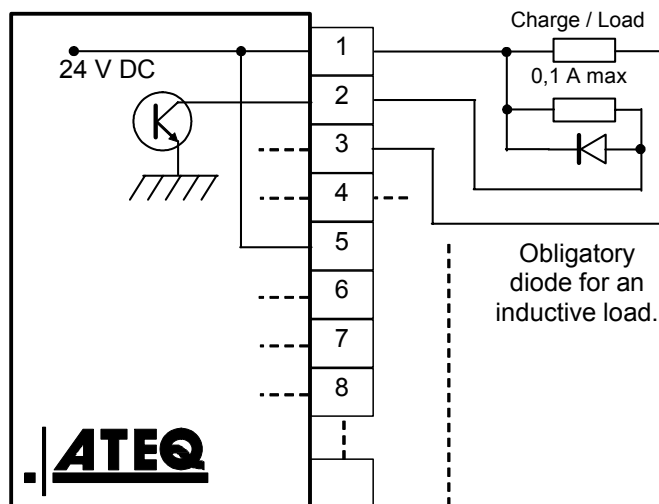

**3.1.10. J10 connector (I/O Inputs/Outputs)**

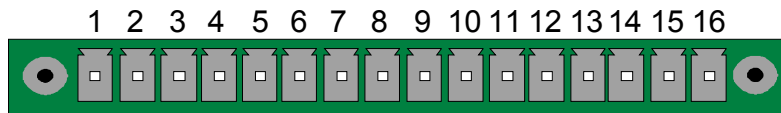

|        |                             |                                                        |
|--------|-----------------------------|--------------------------------------------------------|
| PIN 1  | RESET (input 1)             | INPUTS<br>(Activation by<br>24 V DC)                   |
| PIN 2  | Common (+ 24 V)             |                                                        |
| PIN 3  | START Input (input 2)       |                                                        |
| PIN 4  | Common (+ 24 V)             |                                                        |
| PIN 5  | Input 3 (program selection) |                                                        |
| PIN 6  | Input 4 (program selection) |                                                        |
| PIN 7  | Input 5 (program selection) |                                                        |
| PIN 8  | Input 6 (program selection) |                                                        |
| PIN 9  | Input 7 (program entry)     |                                                        |
| PIN 10 | Floating common outputs     | OUPUTS<br>DRY CONTACTS<br>60V AC / DC Max<br>200mA Max |
| PIN 11 | Part OK output              |                                                        |
| PIN 12 | Part BAD output             |                                                        |
| PIN 13 | Large leak output           |                                                        |
| PIN 14 | Alarm output                |                                                        |
| PIN 15 | End of cycle alarm          |                                                        |
| PIN 16 | 0 V                         |                                                        |

**3.1.10. 1) Activating a program from the J10 connector inputs**

To activate a program from the J3 connector inputs, pins 5 to 8 must be selected (one or more at a time). Binary code n + 1.

**Pin combinations for program selection**

| Program number | Pin 5<br>(Input 3) | Pin 6<br>(Input 4) | Pin 7<br>(Input 5) | Pin 8<br>(Input 6) |
|----------------|--------------------|--------------------|--------------------|--------------------|
| 1              | 0                  | 0                  | 0                  | 0                  |
| 2              | 1                  | 0                  | 0                  | 0                  |
| 3              | 0                  | 1                  | 0                  | 0                  |
| 4              | 1                  | 1                  | 0                  | 0                  |
| 5              | 0                  | 0                  | 1                  | 0                  |
| 6              | 1                  | 0                  | 1                  | 0                  |
| 7              | 0                  | 1                  | 1                  | 0                  |
| 8              | 1                  | 1                  | 1                  | 0                  |
| 9              | 0                  | 0                  | 0                  | 1                  |
| 10             | 1                  | 0                  | 0                  | 1                  |
| 11             | 0                  | 1                  | 0                  | 1                  |
| 12             | 1                  | 1                  | 0                  | 1                  |
| 13             | 0                  | 0                  | 1                  | 1                  |
| 14             | 1                  | 0                  | 1                  | 1                  |
| 15             | 0                  | 1                  | 1                  | 1                  |
| 16             | 1                  | 1                  | 1                  | 1                  |

**3.1.10. 2) J10 Connector (I/O Inputs/Outputs) programmable input**

Input 7 can be parameterised in the **CONFIGURATION/ INPUT OUPUT** menu.

- ✓ Program selection
- ✓ Auto zero reset request,
- ✓ Infinite fill request.

Some possibilities only appear if the function is used.

**3.1.10. 3) J10 Connector (I/O Inputs/Outputs) drawing**

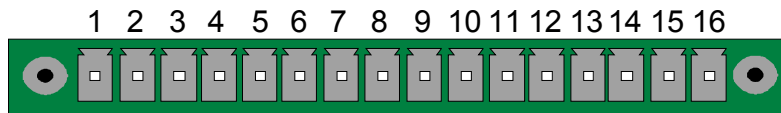

**3.1.10. 4) PLC in NPN mode connection**

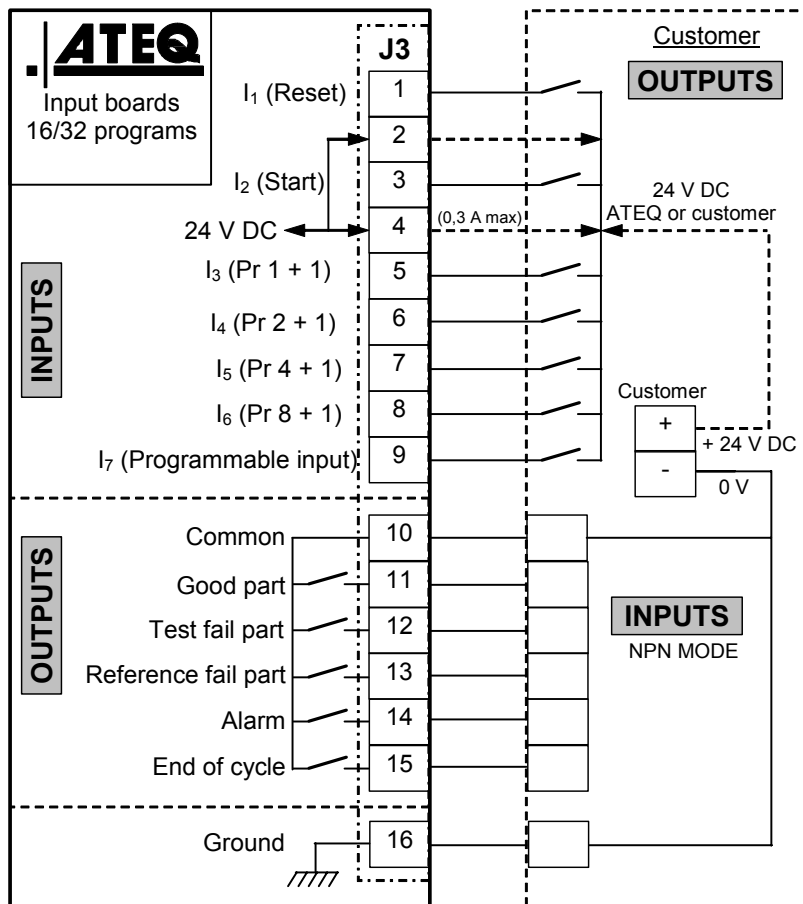

**Note:** The 24V power supply must be provided by the internal power supply of the ATEQ instrument (0,3A maximum) **OR** through an external power supply provided by the customer.

In the case of customer external supply, the ATEQ instrument can be supply by the 2 and 4 pins on the J3 connector too.

3.1.10. 5) PLC in PNP mode connection

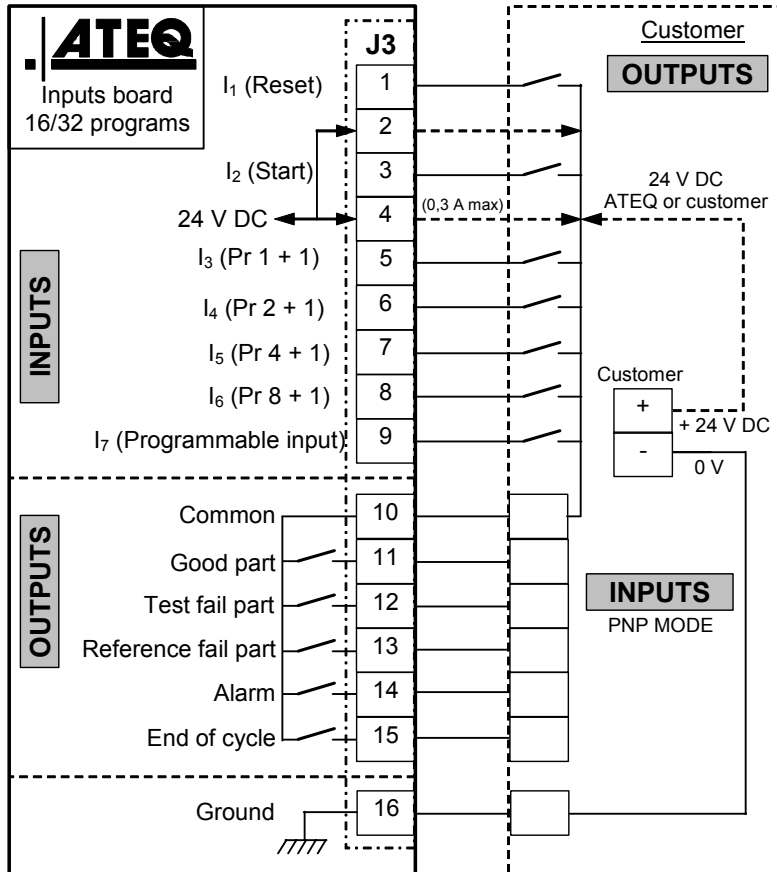

**Note:** The 24V power supply must be provided by the internal power supply of the ATEQ instrument (0,3A maximum) **OR** through an external power supply provided by the customer.

In the case of customer external supply, the ATEQ instrument can be supply by the 2 and 4 pins on the J3 connector too.

3.1.10. 6) Lights connection

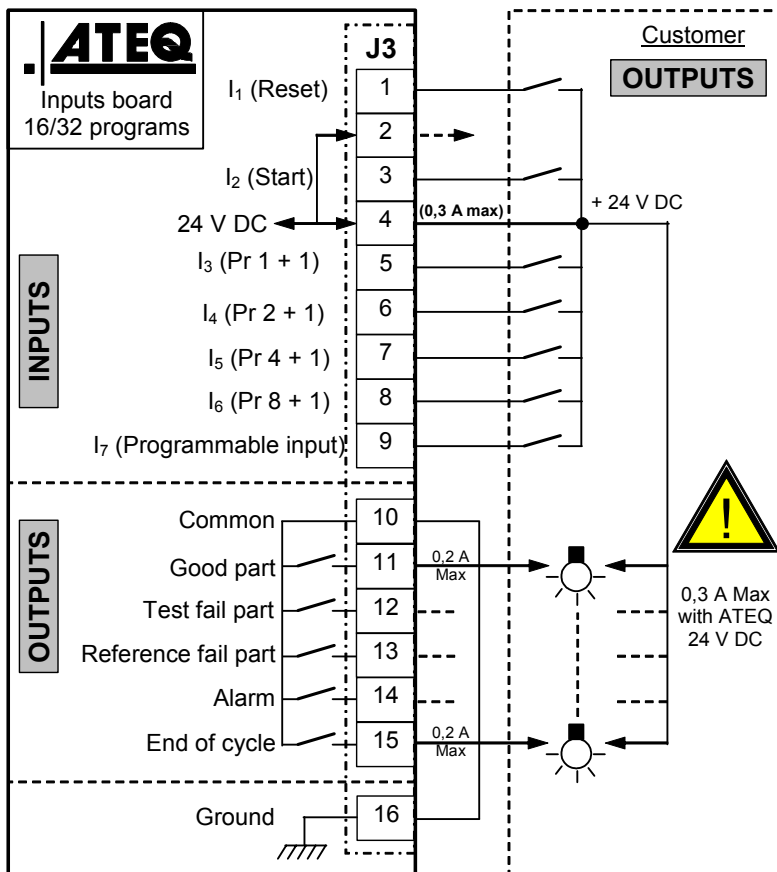

**Note:** The 24V power supply must be provided by the internal power supply of the ATEQ instrument (0,3A maximum) **OR** through an external power supply provided by the customer.

In the case of customer external supply, the ATEQ instrument can be supply by the 2 and 4 pins on the J3 connector too.

### 3.2. PNEUMATIC CONNECTORS

Pneumatic connectors are rear panel of the **G570** instrument.

These pneumatic outputs can carry out the following functions, depending on the configuration demanded at purchase.

| Output "automatic connector A" | Output "automatic connector"        |
|--------------------------------|-------------------------------------|
| Automatic connector A          | Automatic connector B               |
| Automatic connector A          | Stamping (output 1 code used)       |
| Automatic connector A          | External dump (output 2 code used)  |
| Stamping (output 1 code used)  | Dump (output 2 code used)           |
| Automatic connector A          | Shut off valve (output 2 code used) |
| Stamping (output 1 code used)  | Shut off valve (output 2 code used) |

#### 3.2.1. Automatic connector A



Used for connection of an automatic pneumatic connector.

#### 3.2.2. Automatic connector B



Used for connection of a second automatic pneumatic connector.

#### 3.2.3. Pneumatic test output

This output allows to connect the part to be tested.

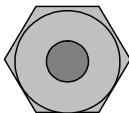

**T** : Test output.

### 3.3. PNEUMATIC SUPPLY

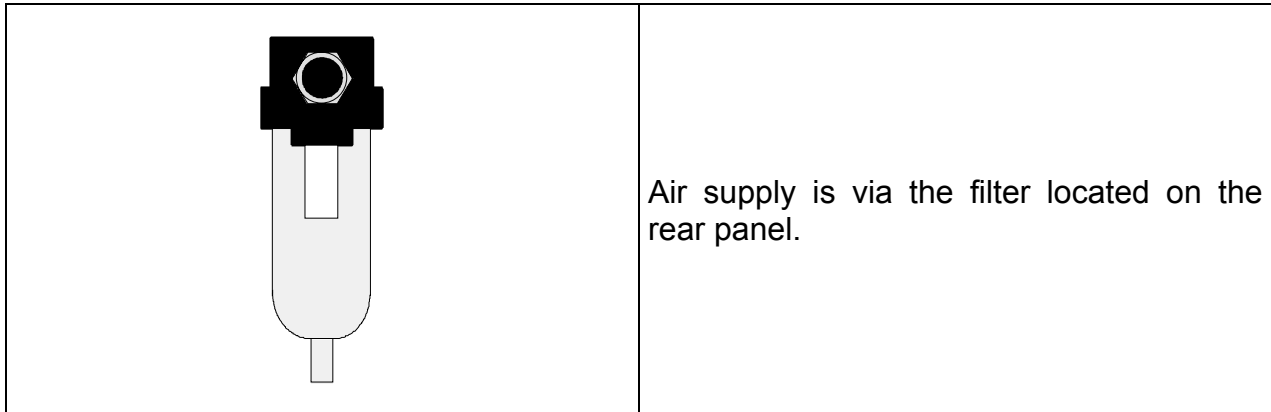

It is essential that the air supplied is clean and dry. Even though there is a filter, supplied with the instrument, the presence of dust, oil or impurities may cause malfunction.

When the instrument is working in vacuum conditions, impurities must be prevented from being drawn into its interior. For this purpose we strongly recommend that a suitable airtight filter is installed between the test part and the instrument. This filter can be supplied by **ATEQ**.

**The presence of impurities, oil or humidity in the air may cause deterioration which will not be covered by the guarantee.**

**In accordance with ISO standard 8573-1 concerning classes of compressed air for measurement instruments in an industrial environment :**

**ATEQ recommends:**

- |                                |         |                                     |
|--------------------------------|---------|-------------------------------------|
| • Grain size and concentration | CLASS 1 | (0.1 µm and 0.1 mg/m <sup>3</sup> ) |
| • Dew point under pressure     | CLASS 2 | (- 40° dew)                         |
| • Maximum concentration of oil | CLASS 1 | (0.01 mg/m <sup>3</sup> )           |

**ATEQ recommends the installation :**

- of an air dryer to provide dry air at less than - 40° dew point,
- of a 25 micron and 1/100 micron double filter.

**Optimisation of operation:**

The supply pressure must always be between 4 and 8 bar to ensure that the pneumatic distributors operate with optimum efficiency.

**When a mechanical regulator is used, the supply pressure must be a minimum of 100 kPa (1 bar) greater than test pressure with a minimum of 400 kPa (4 bar).**



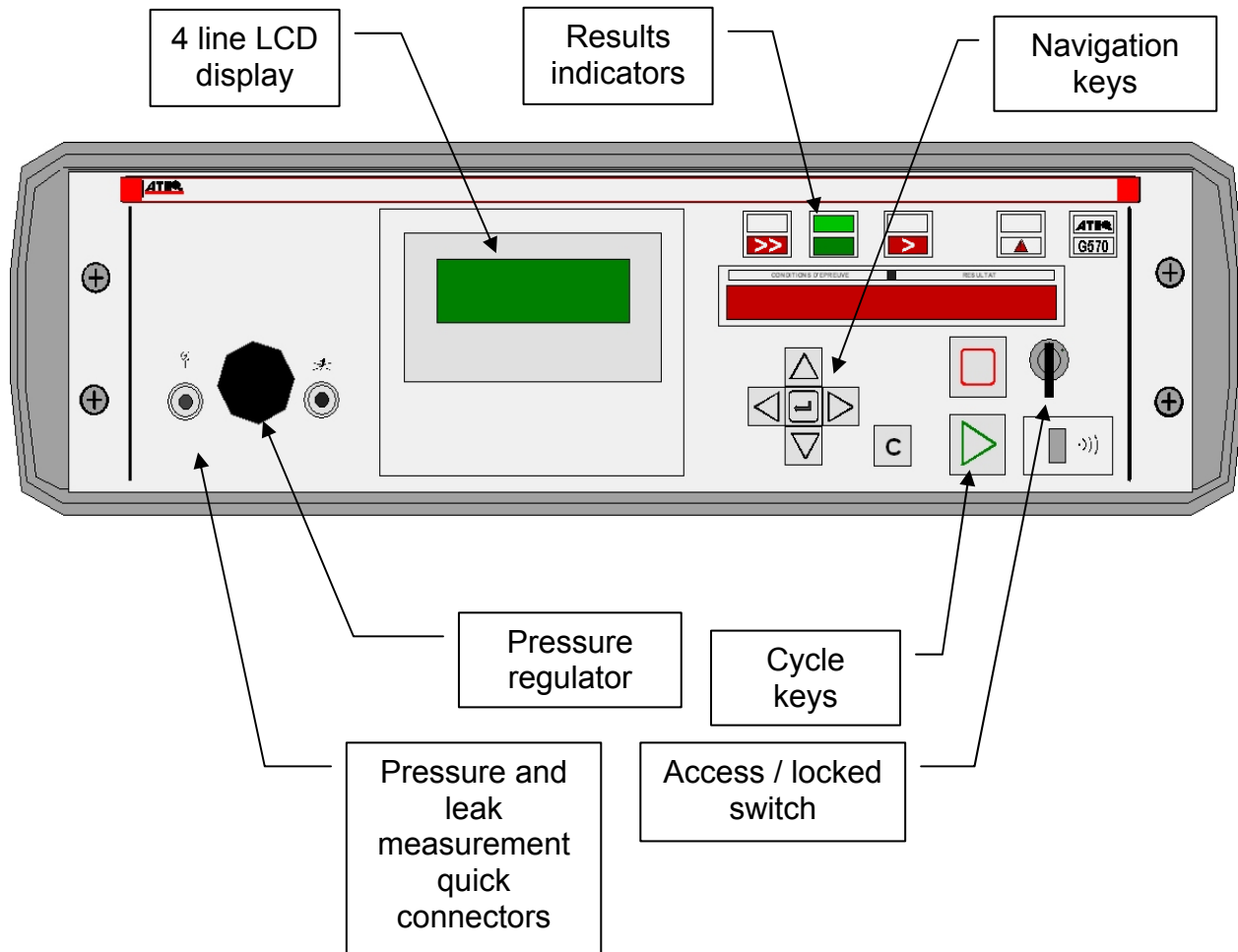

## Chapter 2 USER INTERFACES

### 1. ATEQ G520 FRONT PANEL APPEARANCE

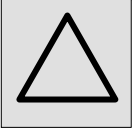
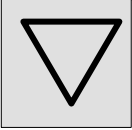
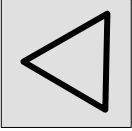
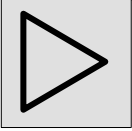

## 2. APPEARANCE OF THE KEYBOARD

### 2.1. NAVIGATION KEYS

| KEY                                                                                 | FUNCTION                                                                                                          |
|-------------------------------------------------------------------------------------|-------------------------------------------------------------------------------------------------------------------|
|    | Scroll up or increase numerical values                                                                            |
|    | Scroll down or decrease numerical values                                                                          |
|    | Not used                                                                                                          |
|   | Not used                                                                                                          |
|  | <b>ENTER</b> key<br>Opening a menu<br>Entering a parameter<br>Confirmation of a parameter                         |
|  | « <b>C</b> » for <b>CANCEL</b><br>Return to the previous menu or function<br>Escape without modifying a parameter |

### 2.2. CYCLE KEYS

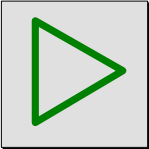
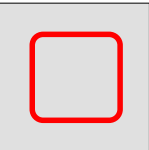
| KEY                                                                                 | FUNCTION                                       |
|-------------------------------------------------------------------------------------|------------------------------------------------|
|  | <b>START</b> key<br>Starts a measurement cycle |
|  | <b>RESET</b> key<br>Stops a cycle in progress  |

### 3. LOCKABLE SWITCH

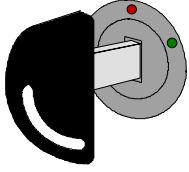
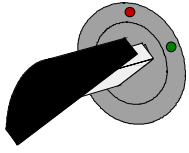
| POSITION                                                                          | FUNCTION                                                                         |
|-----------------------------------------------------------------------------------|----------------------------------------------------------------------------------|
|  | <p><b>LOCKED</b> position.<br/>Access to adjustable parameters not possible.</p> |
|  | <p><b>ACCESS</b> position.<br/>Adjustable parameters may be accessed.</p>        |

**Note:** whatever position the key is in (**LOCKED** or **ACCESS**), test cycles can be started and stopped.

### 4. 4 LINE LCD DISPLAY



Used to display measurements and adjustable parameters. In the example opposite, XX.XXi represents the program version for the instrument.

### 5. 14 CHARACTER LED DISPLAY

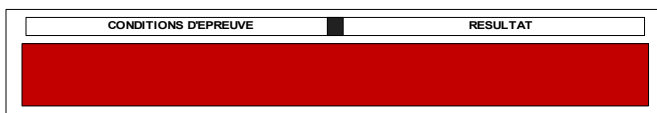

Allows the display of measurements and adjustable parameters.

### 6. QUICK CONNECTOR

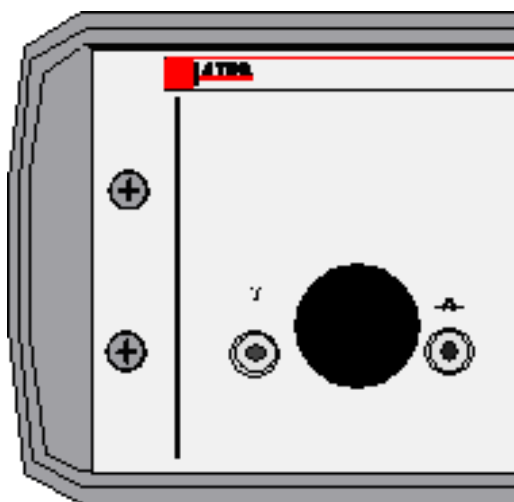

A quick connector may be mounted on the front panel of the instrument. It allows the easy checking of the pressure. It is used for the regulator circuit. It allows the checking of the test pressure displayed by the instrument with a precision manometer or the **ATEQ Leak/Flow calibrator**.

## 7. INFRA-RED INTERFACE

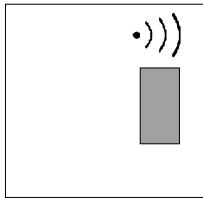



Not used.

## 8. FUNCTIONS OF THE INDICATOR LIGHTS

The  symbol represents an indicator which is lit.

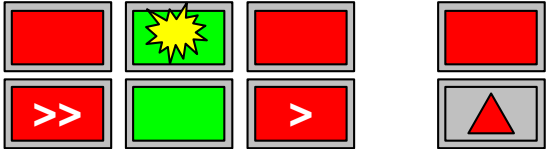
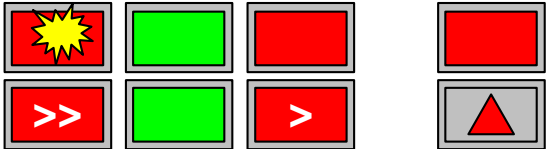
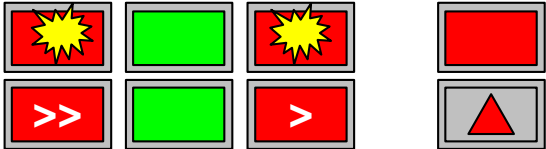
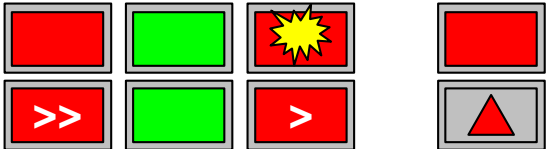
The  symbol represents an indicator which is flashing.

|                                                                                                                                                     |                                                                                      |
|-----------------------------------------------------------------------------------------------------------------------------------------------------|--------------------------------------------------------------------------------------|
| Test part OK indicator                                                                                                                              |    |
| Large leak mode or fill in progress indicator (automatic start mode).                                                                               |   |
| Pressure fault                                                                                                                                      |  |
| Part BAD indicator and leak over the full scale                                                                                                     |  |
| Intermittent flashing stand-by or measurement between thresholds 1 and 2 of negative flow. Refer to chapter 4 paragraph 2.12. "negative flow alarm" |  |
| Alarm indicator (sensor fault, leak over the reference full scale, ...)                                                                             |  |



## Chapter 3

## INSTALLATION AND SETTINGS



## 1. POWERING UP THE ATEQ G570

|                                                                       |                                                                    |
|-----------------------------------------------------------------------|--------------------------------------------------------------------|
| Supply the apparatus with 24 V DC.<br>When powered up the instrument: |                                                                    |
| displays version and the full scale of the sensors...                 | <pre>ATEQ G5 Version XX.XXi 0-&gt; 500 mbar 100 cm3/h</pre>        |
| Carries out a RESET                                                   | <pre>CYCLE/Pr : 001 PRESS = 400.0 mbar 0-&gt; 500 mbar RESET</pre> |
| ...then displays the main menu.                                       | <pre>CYCLE/Pr : 001 PRESS = 400.0 mbar  READY</pre>                |

## 2. CREATION OF A TEST PROGRAM

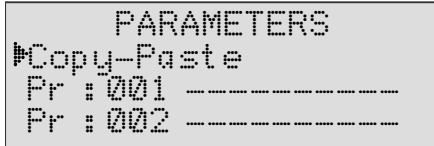

|                                                                                                                                                                                                                                                                                                                                                              |                                                                                     |                                                                      |
|--------------------------------------------------------------------------------------------------------------------------------------------------------------------------------------------------------------------------------------------------------------------------------------------------------------------------------------------------------------|-------------------------------------------------------------------------------------|----------------------------------------------------------------------|
| To modify the parameters, turn the key to the <b>ACCESS</b> position.                                                                                                                                                                                                                                                                                        |  | <pre>RUN/Pr: 001 PRESS = 0.000 bar  READY</pre>                      |
| To access the main menu, press <b>ENTER</b> .<br>In the main menu, place the cursor in front of the <b>PARAMETERS</b> menu.<br>Confirm with the <b>ENTER</b> key.                                                                                                                                                                                            |  | <pre>MAIN MENU RUN PROG. : --- PARAMETERS SPE CYCLE : Disabled</pre> |
| The <b>PARAMETERS</b> menu is used to manage test programs.<br>☞ If the various programs to be created have different parameters, they must be created one by one.<br>☞ If the programs have identical parameters, a base program can be created and then the <b>Copy-Paste</b> function can be used to duplicate the program as many times as is necessary. |                                                                                     | <pre>PARAMETERS Copy-Paste Pr : 001 ----- Pr : 002 -----</pre>       |

## 2.1. CHOICE OF THE PROGRAM NUMBER

|                                                                                                         |                                                                                                                                                                     |                                                                                    |
|---------------------------------------------------------------------------------------------------------|---------------------------------------------------------------------------------------------------------------------------------------------------------------------|------------------------------------------------------------------------------------|
| <p>Position the cursor in front of the chosen program number and confirm with the <b>ENTER</b> key.</p> |   |  |
|---------------------------------------------------------------------------------------------------------|---------------------------------------------------------------------------------------------------------------------------------------------------------------------|------------------------------------------------------------------------------------|

## 2.2. TEST TYPE SELECTION



Two test types are available.

|                                                                                                                                                                                                                                                                                         |                                                                                                                                                                     |                                                                                    |
|-----------------------------------------------------------------------------------------------------------------------------------------------------------------------------------------------------------------------------------------------------------------------------------------|---------------------------------------------------------------------------------------------------------------------------------------------------------------------|------------------------------------------------------------------------------------|
| <p>The <b>PARAMETERS</b> menu gives access to two possible types of test : flow test (<b>FLOW TEST</b>) and operator test (<b>OPERATOR</b>); see the following paragraph for explanations. Put the cursor in front of the required test type and confirm with the <b>ENTER</b> key.</p> |   |  |
|-----------------------------------------------------------------------------------------------------------------------------------------------------------------------------------------------------------------------------------------------------------------------------------------|---------------------------------------------------------------------------------------------------------------------------------------------------------------------|------------------------------------------------------------------------------------|

### 2.2.1. Flow test

The flow test allows the testing of a part for leaks by measuring a flow which is applied to it. In the event of a part having no leaks, there will be no flow, or one inferior to the reject level set.







### 2.2.2. Operator mode test

This type of test means that the operator can carry out operations on the part whilst under test, then to confirm these operation using a "START"  key if the operator test is good, or "RESET"  key if the test is fail.

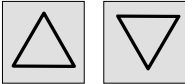
### 2.3. PARAMETER SETTINGS

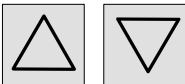
Once the test type is chosen, the test cycle parameters must be set.  
The procedure to follow for setting the test parameters is identical in each case.

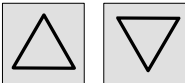
Example : Coupling time A.

|                                                                                                                 |                                                                                     |                                                                             |
|-----------------------------------------------------------------------------------------------------------------|-------------------------------------------------------------------------------------|-----------------------------------------------------------------------------|
| <p>First, position the cursor in front of the chosen parameter using the navigation keys ( here, Coupl. A).</p> |    | <pre>PARAM/pr001 TYPE : FLOW TEST COUPL. A: 00.00 s FILL    : 00.00 s</pre> |
| <p>Then, confirm with the <b>ENTER</b> key. The cursor will move to the right of the display.</p>               |    | <pre>PARAM/pr001 TYPE : FLOW TEST COUPL. A: 00.00 s FILL    : 00.00 s</pre> |
| <p>Modify the value using the navigation keys.</p>                                                              |    | <pre>PARAM/pr001 TYPE : FLOW TEST COUPL. A: 00.03 s FILL    : 00.00 s</pre> |
| <p>Once the value is modified, confirm with the <b>ENTER</b> key.</p>                                           |   | <pre>PARAM/pr001 TYPE : FLOW TEST COUPL. A: 03.00 s FILL    : 00.00 s</pre> |
| <p>To move on to the next parameter, use the navigation keys.</p>                                               |  | <pre>PARAM/pr001 TYPE : FLOW TEST COUPL. A: 03.00 s FILL    : 00.00 s</pre> |
| <p>To exit from the menu, use the <b>CANCEL</b> key.</p>                                                        |  | <pre>PARAMETERS Cut-Paste Pr: 001 FLOW TEST Pr: 002 FLOW TEST</pre>         |

### 2.3.1. Coupling time

Coupling times A and B are start of cycle parameters.

If there is no automatic connector, Coupling time A is part of the cycle.

If an instrument is fitted with an automatic connector, Coupling time A delays the pressurisation of the test part by allowing the activation of a first cycle connector at the test start. Coupling time B allows the activation of a second automatic connector. These Coupling times ensure better stabilization of the seals placed on the test part.

☞ Set this parameter using the method described in § 2.3.

### 2.3.2. Fill time

This is the time allowed for the pressurisation of the part to be tested. It must not be too long (waste of time) or too short (the pressure in the component is at risk of not being sufficient due to drops in pressure caused by temperature changes).

To determine the appropriate fill time, it is necessary to set the **Fill Time** in order to make it too long, then to shorten it until a drop in pressure occurs due to thermal effects.

- ✓ Carry out a cycle. When the instrument switches to the stabilization period, the pressure must remain stable.
- ✓ A pressure drop (since there will be no fall in pressure due to thermal effects) signifies the presence of a large leak; check the test part and the pneumatic assembly components, then start again.
- ✓ If the pressure remains stable, the part does not contain a large leak and the fill time is too long. Shorten it progressively by carrying out cycles until a drop in pressure is noticeable.
- ✓ As soon as a fall in pressure due to thermal effects appears, the fill time has become too short. Increase it slightly.

☞ Set this parameter using the method described in § 2.3.

### 2.3.3. Stabilization time

This time is used to stabilise the pressure in the test circuit.

It is possible that a change in pressure occurs due to thermal exchanges between the components. If the instrument takes a measurement too early, the instrument will indicate the presence of a large leak.

- ✓ To determine the correct stabilization time, it is necessary to set a long time so that the reading at the end of the test time is equal to zero.
- ✓ Set the stabilization time to four times the length of the fill time.
- ✓ Carry out a cycle. When the instrument switches to the test period, the flow must remain at zero.
- ✓ If there is a drop in pressure, there is a small leak present. Check the test part and the pneumatic connections, then start again.
- ✓ If the flow is close to nil, the part does not contain a small leak and the stabilization time is therefore too long. Progressively shorten and carry out cycles (wait one minute between each cycle) until you see the appearance of a drop in flow. This indicates that the stabilization time has become too short. Increase it slightly.

☞ Set this parameter using the method described in § 2.3.

### 2.3.4. Test time

The test time depends on the reject level as the test pressure is supplied by the reserve. The greater the leak is, the faster the pressure drops.

A compromise must therefore be found between the stabilization and test times to obtain a flow measurement at a pressure as close as possible to that of the set (instruction) pressure.

**NB:** in "Auto Start" mode, the test time parameter is removed (infinite test).

☞ Set this parameter using the method described in § 2.3.

### 2.3.5. Pressure units

The different units are bar, mbar, PSI, Pa, kPa, MPa. .

☞ Set this parameter using the method described in § 2.3.

### 2.3.6. Set pressure

This instruction is the test pressure which must be applied to the part. This is because the flow will be constantly recalculated for this set pressure. Beyond a drop of 10 to 20 % in pressure, the error on the flow becomes significant. It is therefore important to have a real test pressure as close as possible to that of the set instruction pressure.

When setting the parameters for a new test cycle (creation of a new program) the default instruction pressure displayed is the value of the calibration pressure which was set in the factory.

☞ Set this parameter using the method described in § 2.3.

### 2.3.7. Maximum fill

This function is used to set a maximum limit for the fill pressure which triggers an alarm if this limit is exceeded. This threshold is automatically calculated to +20% after the validation of the instruction pressure and can be modified manually.

When test time is infinite, the maximum fill pressure monitoring remains in operation.

☞ Set this parameter using the method described in § 2.3.

### 2.3.8. Minimum fill

This function is used to set a minimum limit for the fill pressure which triggers an alarm if it is not reached.

This function is used to set a minimum limit for the fill pressure which triggers an alarm if this limit is not reached. This threshold is automatically calculated to -20% after the validation of the instruction pressure and can be modified manually.

When test time is infinite, the minimum fill pressure monitoring remains in operation.

☞ Set this parameter using the method described in § 2.3.

### 2.3.9. Test pressure adjustment

The adjustment of the pressure on the regulator can be carried out when the instrument is not in a test cycle, with a good part connected to the instrument (permanent flow).

### 2.3.10. Reject unit

The reject units are: ml/min, ml/h.

☞ Set this parameter using the method described in § 2.3.

### 2.3.11. Volume

The volume parameter is imperative for the flow measurement.

It's the total volume connected to the test output.

It's exists a special cycle "**Volume calculation**" who allows to estimate the volume if is not known (see the chapter 4 paragraph 2.1.3.15) "Volume calculation").

☞ Set this parameter using the method described in § 2.3.

### 2.3.12. Test reject

This function is used to set a limit level below which the part is considered to be bad.

☞ Set this parameter using the method described in § 2.3.







### 2.3.13. Functions

The **FUNCTION** menu gives access to additional parameters which must first be activated in the **CONFIGURATION** menu and then the **EXTENDED MENU**.

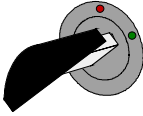
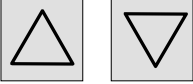
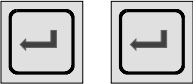
If no additional parameters are confirmed in the **EXTENDED MENUS**, the **FUNCTION** menu will be empty when selected.

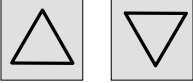



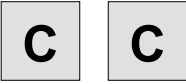

To activate these parameters, refer to chapter 4 § 2.

### 3. DUPLICATION OF A TEST PROGRAM

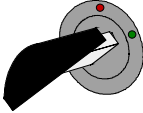
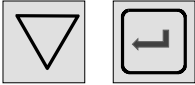
|                                                                                                                                                              |                                                                                     |                                                                                           |
|--------------------------------------------------------------------------------------------------------------------------------------------------------------|-------------------------------------------------------------------------------------|-------------------------------------------------------------------------------------------|
| <p>To modify the parameters, turn the key to the <b>ACCES</b> position.</p>                                                                                  |    |                                                                                           |
| <p>Starting from the main menu, position the cursor in front of the <b>PARAMETERS</b> function.</p>                                                          |    | <pre> MAIN MENU RUN PROG.: 001 PARAMETERS SPE CYCLE : Disabled                     </pre> |
| <p>Confirm with the <b>ENTER</b> key. The cursor will appear in front of the Copy-Paste function. Confirm the function again using the <b>ENTER</b> key.</p> |    | <pre> PARAMETERS Copy-Paste Pr : 001 ENGINE Pr : 002 HEAD                     </pre>      |
| <p>Next, confirm the <b>COPY</b> function.</p>                                                                                                               |    | <pre> PARAM/Copy-Paste COPY      : Pr --- PASTE     : Pr ---                     </pre>   |
| <p>Display the number of the program to be copied using the navigation keys. (In this case, program no.1).</p>                                               |   | <pre> PARAM/Copy-Paste COPY      : Pr 001 PASTE     : Pr ---                     </pre>   |
| <p>Confirm using the <b>ENTER</b> key.</p>                                                                                                                   |  | <pre> PARAM/Copy-Paste COPY      : Pr 001 PASTE     : Pr ---                     </pre>   |
| <p>Place the cursor in front of <b>PASTE</b>.</p>                                                                                                            |  | <pre> PARAM/Copy-Paste COPY      : Pr 001 PASTE     : Pr ---                     </pre>   |
| <p>Confirm with the <b>ENTER</b> key. Assign a number to this new program using the navigation keys (For example no.3).</p>                                  |  | <pre> PARAM/Copy-Paste COPY      : Pr 001 PASTE     : Pr 003                     </pre>   |
| <p>Confirm with the <b>ENTER</b> key, The display confirms that the program has been copied.</p>                                                             |  | <pre> COPY IN PROGRESS                     </pre>                                         |
| <p>The program no.1 parameters have now been copied into program no.3 parameters. In this example program no.3 is an exact copy of program n°1.</p>          |                                                                                     | <pre> PARAM/Copy-Paste COPY      : Pr 001 PASTE     : Pr 003                     </pre>   |





|                                                                      |                                                                                   |                                                                                         |
|----------------------------------------------------------------------|-----------------------------------------------------------------------------------|-----------------------------------------------------------------------------------------|
| <p>Press the <b>CANCEL</b> key twice to return to the main menu.</p> |  | <pre> MAIN MENU PARAMETERS SPE CYCLE: Disabled CONFIGURATION                     </pre> |
|----------------------------------------------------------------------|-----------------------------------------------------------------------------------|-----------------------------------------------------------------------------------------|

#### 4. DELETING A PROGRAM OR A PROGRAM NAME

|                                                                                                                                                    |                                                                                     |                                                                                               |
|----------------------------------------------------------------------------------------------------------------------------------------------------|-------------------------------------------------------------------------------------|-----------------------------------------------------------------------------------------------|
| <p>To modify the parameters, turn the key to the <b>ACCES</b> position.</p>                                                                        |    |                                                                                               |
| <p>Position the cursor in front of <b>PARAMETERS</b> function. Confirm with the <b>ENTER</b> key.</p>                                              |    | <pre> MAIN MENU RUN PROG.: 001 PARAMETERS SPE CYCLE : Disabled                     </pre>     |
| <p>Position the cursor in front of the program number or the program name to be deleted.</p>                                                       |    | <pre> PARAMETERS Copy-Paste Pr: 001 ENGINE Pr: 002 HEAD                     </pre>            |
| <p>Confirm once to enter the program.</p>                                                                                                          |  | <pre> PARAM/Pr001 TYPE : FLOW TEST WAIT A: 00.00 s WAIT B: 00.00 s                     </pre> |
| <p>Confirm a second time to gain access to the delete menu. There are two possibilities : delete the program name or delete the whole program.</p> |  | <pre> M/Pr001/TEST TYPE Delete name Program reset                     </pre>                  |
| <p>1°) Confirm a third time. The name of the program is deleted.</p>                                                                               |  | <pre> PARAMETERS Copy-Paste Pr: 001 ----- Pr: 002 HEAD                     </pre>             |
| <p>2°) Place the cursor in front of Program reset.</p>                                                                                             |  | <pre> M/Pr001/TEST TYPE Delete name Program reset                     </pre>                  |
| <p>Confirm with the <b>ENTER</b> key. The program is then deleted.</p>                                                                             |  | <pre> PARAMETERS Copy-Paste Pr: 001 ----- Pr: 002 HEAD                     </pre>             |

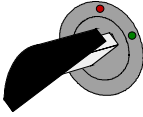
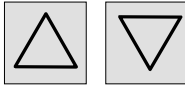
**Note:** If the “Program delete” operation is carried out first, then the program name is also deleted.

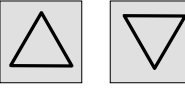
### 5. CHOICE OF THE PROGRAM TO BE RUN

|                                                                                                              |                                                                                     |                                                                                              |
|--------------------------------------------------------------------------------------------------------------|-------------------------------------------------------------------------------------|----------------------------------------------------------------------------------------------|
| <p>Position the key in the <b>ACCESS</b> position.</p>                                                       |    |                                                                                              |
| <p>Starting from the main menu, place the cursor in front of the <b>RUN PROG.</b> function.</p>              |    | <pre> MAIN MENU ▶RUN PROG.: 001 PARAMETERS SPE CYCLE : Disabled                     </pre>   |
| <p>Confirm with the <b>ENTER</b> key.</p>                                                                    |    | <pre> MAIN MENU ▶RUN PROG.: 001 PARAMETERS SPE CYCLE : Disabled                     </pre>   |
| <p>Display the number of the program required by scrolling through the numbers with the navigation keys.</p> |    | <pre> MAIN MENU RUN PROG. : 004 ◀ PARAMETERS SPE CYCLE : Disabled                     </pre> |
| <p>Confirm your choice with the <b>ENTER</b> key.</p>                                                        |  | <pre> MAIN MENU ▶RUN PROG. : 004 PARAMETERS SPE CYCLE : Disabled                     </pre>  |

### 6. STARTING A MEASUREMENT CYCLE

|                                                                                       |                                                                                     |                                                                               |
|---------------------------------------------------------------------------------------|-------------------------------------------------------------------------------------|-------------------------------------------------------------------------------|
| <p>Press the <b>START</b> key to start a measurement cycle.</p>                       |  | <pre> RUN/Pr: 004 PRESS =0.500 bar  READY                     </pre>          |
| <p>The cycle phases appear on the display: wait, fill, stabilization, test, dump.</p> |                                                                                     | <pre> CYCLE/Pr: 004 PRESS =1.00 bar  STABILIZATION                     </pre> |

### 7. STOPPING A CYCLE

|                                                                                                                                                                 |                                                                                     |                                                                      |
|-----------------------------------------------------------------------------------------------------------------------------------------------------------------|-------------------------------------------------------------------------------------|----------------------------------------------------------------------|
| <p>Press the <b>RESET</b> key to stop the measurement. The display <b>“READY”</b> indicates that the instrument is ready to perform a new measurement test.</p> |  | <pre> RUN/Pr: 004 PRESS =0.500 bar  READY                     </pre> |
|-----------------------------------------------------------------------------------------------------------------------------------------------------------------|-------------------------------------------------------------------------------------|----------------------------------------------------------------------|

## Chapter 4

# FUNCTIONS OF THE INSTRUMENT

### 1. MENU STRUCTURE

#### 1.1. MAIN MENU

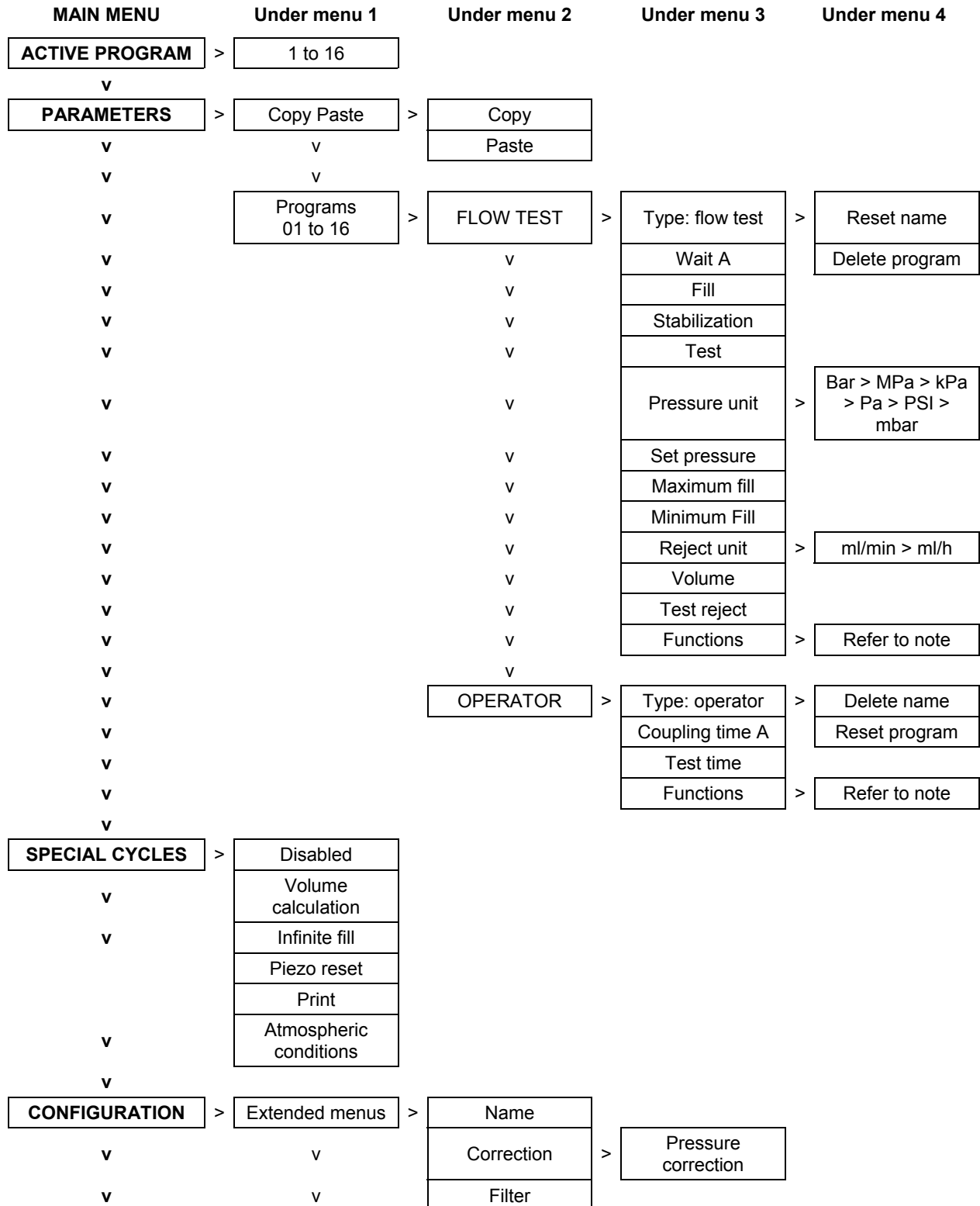

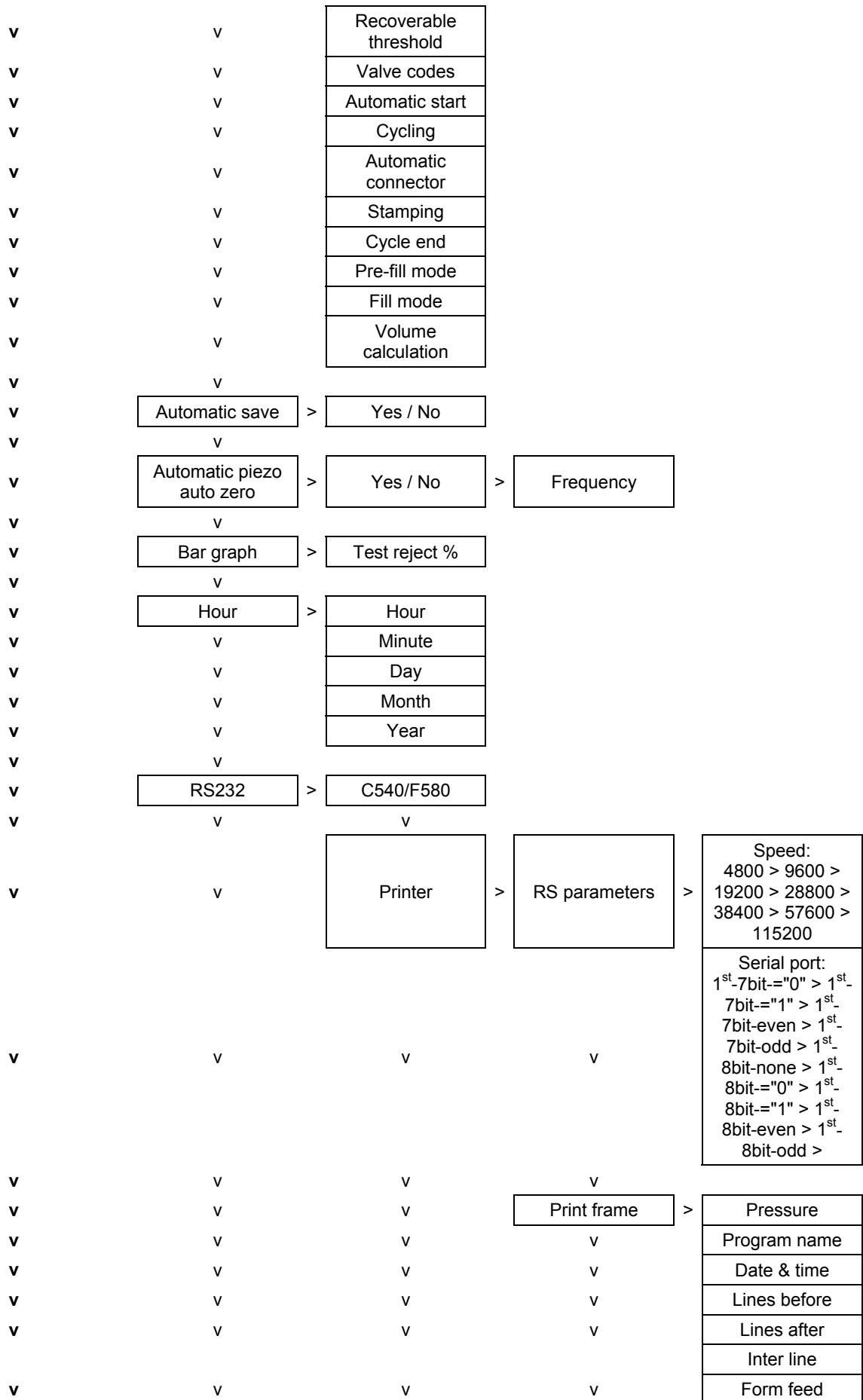



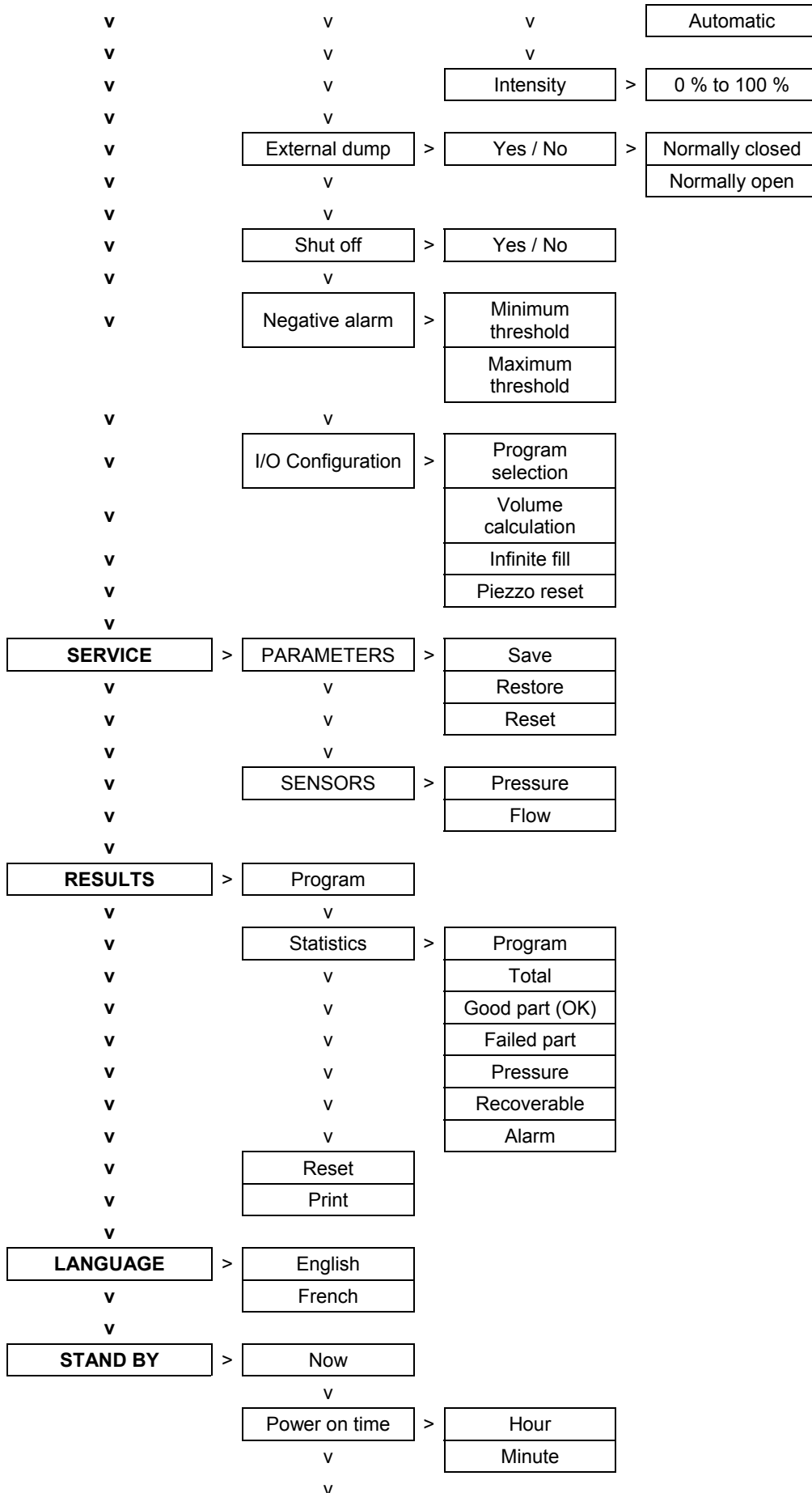

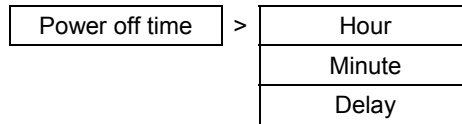

**Note:** The parameters that feature in the **EXTENDED MENUS** can be found in the **FUNCTIONS** menu of the program when they are activated (refer to the following chapter).

### 1.2. "FUNCTIONS" MENU WHEN ACTIVATED

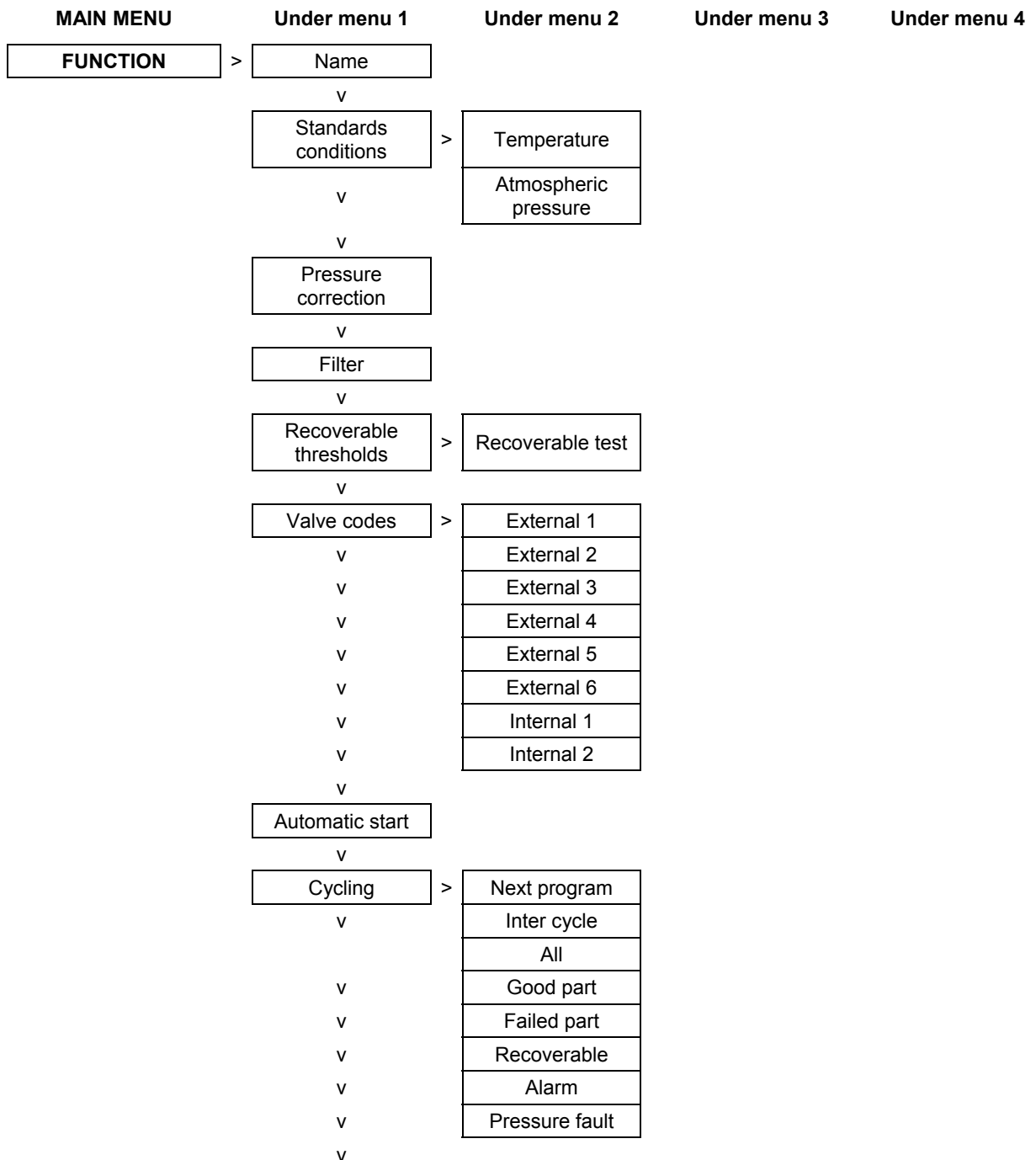

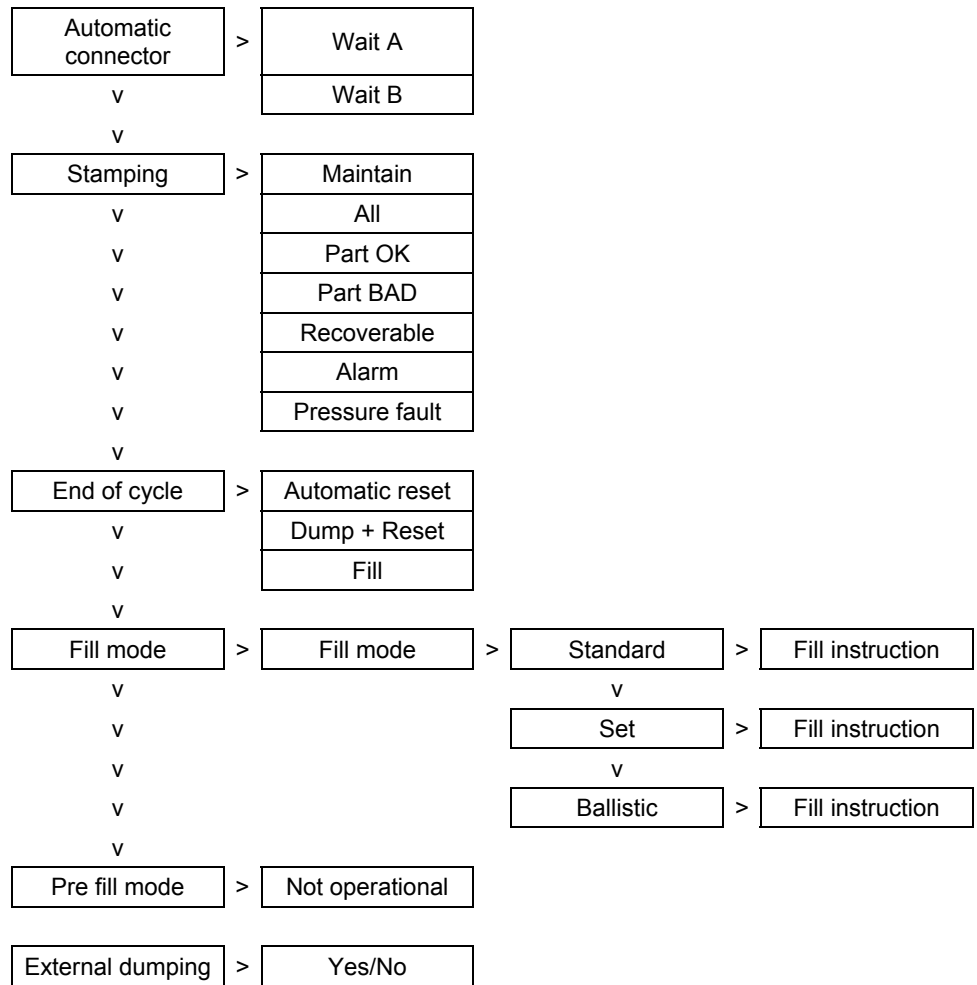









## 2. CONFIGURATION MENU

### 2.1. EXTENDED MENUS

The extended menus offer access to additional functions. If these functions are activated, they can be found in the **FUNCTION** menu when a program is created. If no additional functions are activated, the **FUNCTION** menu will be empty when a program is created. .

#### 2.1.1. Activation of the additional functions

|                                                                                                                                                                                                                                                                       |                                                                                                                                                                                                                                                                                                                                                    |                                                                                                |
|-----------------------------------------------------------------------------------------------------------------------------------------------------------------------------------------------------------------------------------------------------------------------|----------------------------------------------------------------------------------------------------------------------------------------------------------------------------------------------------------------------------------------------------------------------------------------------------------------------------------------------------|------------------------------------------------------------------------------------------------|
| <p>In the main menu, place the cursor in front of the <b>CONFIGURATION</b> label</p>                                                                                                                                                                                  |                                                                                                                                                                                                                                                                   | <pre> MAIN MENU SPE CYCLE : Disabled CONFIGURATION RESULTS                     </pre>          |
| <p>Confirm using the <b>ENTER</b> key.</p>                                                                                                                                                                                                                            |                                                                                                                                                                                                                                                                   | <pre> CONFIGURATION EXTENDED MENUS PRINTER : YES HOUR                     </pre>               |
| <p>Next, confirm the <b>EXTENDED MENUS</b> function with the <b>ENTER</b> key. The list of additional functions is then displayed.</p>                                                                                                                                |                                                                                                                                                                                                                                                                 | <pre> CONFIG/EXTEND MENUS NAME : No CYCLING : No AUTO CONNECT : No                     </pre>  |
| <p>To activate a function (e.g. the <b>NAME</b> function), confirm it with the <b>ENTER</b> key. Next, choose <b>YES</b> with the navigation keys and confirm again with the <b>ENTER</b> key. Start the operation again if you need to activate other functions.</p> |  <br>  | <pre> CONFIG/EXTEND MENUS NAME : Yes CYCLING : No AUTO CONNECT : No                     </pre> |
| <p>Once all the chosen functions are activated, press the <b>CANCEL</b> key twice to return to the main menu.</p>                                                                                                                                                     |                                                                                                                                                                              | <pre> MAIN MENU SPE CYCLE : Disabled CONFIGURATION RESULTS                     </pre>          |

### 2.1.2. Setting the additional functions

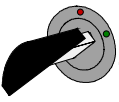
- ✓ Place the key in the **ACCESS** position .
- ✓ Create a new program (refer to chapter 3 §2 "Creation of a test program").
- ✓ In the parameters list for this new program, confirm the **FUNCTIONS** parameter (refer to chapter 3 § 2.3 "Parameter settings").

 **Only the functions which have been activated using the above method will appear in the FUNCTIONS parameter.**

### 2.1.3. List of additional functions

#### 2.1.3. 1) Name

This function is used to customise a program, for example to name a program after the part to be tested.

 Select the option and enter settings if necessary.

#### 2.1.3. 2) Standard conditions

The "Standard conditions" function allows bringing down the results measured by the instrument to define atmospheric conditions.

The measurement depends of the surrounding temperature and the surrounding atmospheric pressure. When this function is activated, the instrument calculates the flow results with regards to the parameters of atmospheric conditions captured. Like this the measurement results will take no notice of the surrounding variations.

To indicate the validation of this function, an asterisk is displayed after "**FLOW**".

 Select the option and enter settings if necessary.

#### 2.1.3. 3) Pressure correction

The "pressure correction" function allows bringing down the measurement results by the instrument to a pressure condition defined in instruction.

When the function is activated, the instrument calculates the flow results with regards to the instruction pressure. Like this the results will take no notice of the pressure variations.

 Select the option and enter settings if necessary.

#### 2.1.3. 4) Filtering

This parameter enables the modifying of the time constant for the display of the leak value during the test time.

It enables the filtering of extreme variations in flow if they exist.

The parameter is set in seconds, the longer the time set is, the greater the filtering (or dampening) and the slower the display of the variations in flow will be.

 Select the option and enter settings if necessary.

### 2.1.3. 5) Recovery limits

This option offers the option of two reject levels: non-tolerance level (the bad part is not recoverable) and recoverable reject level (the part is bad but may be reworked to become acceptable). This option is particularly used in casting, when parts are intended for treatment via impregnation.

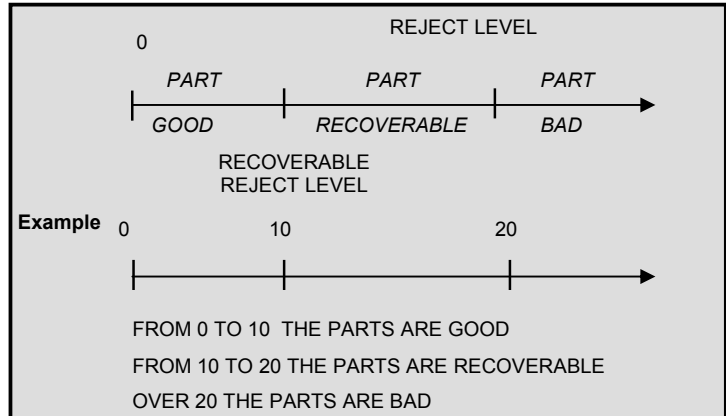

The associated parameter to be set is: RECUP Test.

For recoverable parts, with multi-head configuration on the central unit or on the heads themselves, the Pass (PB) and Fail (PM) outputs are both activated simultaneously. On the RS232 output, there is a message (DT) in the same way as there is for a bad part.

☞ Select the option and enter settings if necessary.

### 2.1.3. 6) Valve codes

The instrument has eight programmable electrical outputs (24V DC / 100 mA maximum) of which four may be reserved due to the presence of the stamping option (Valve code 1 internal and external) and external dumping (internal and external valve 2 code). These outputs (one or more) be attributed to program numbers. In general, they are used to select valves in sequence of cycles. The desired outputs may be activated for each program (Refer to chapter 1 paragraph 3.1.9).

Associated parameters to be adjusted: External 1, External 2, External 3, External 4, External 5, External 6, Internal 1, Internal 2.

☞ Select the option and enter settings if necessary.

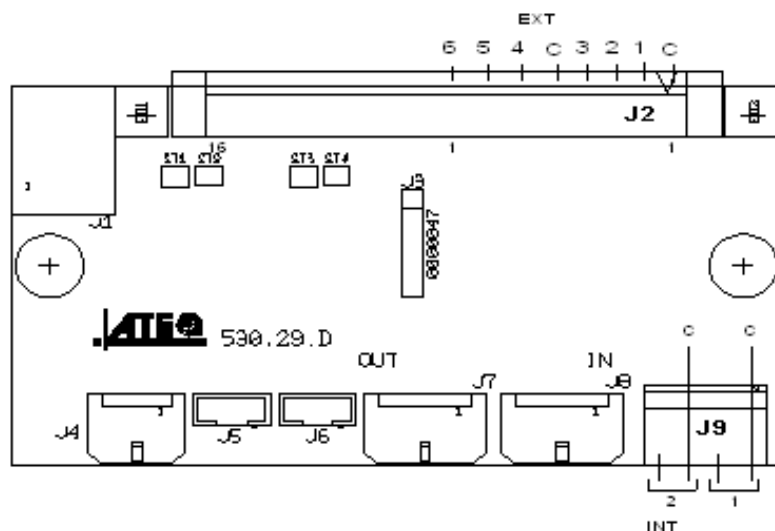



**2.1.3. 7) Automatic start (Auto start)**

The automatic start function allows the launching of a test cycle as soon as the part is connected to the test measurement, it therefore negates the need for the operator to press the start key. The part is detected due to a change in the flow in the measurement circuit.

The automatic start inhibits certain functions which are incompatible with the mode: automatic connector, stamping, external dump, cycle end, pre-fill, shut-off valve, chaining, double pressure and fill type.

The "test time" parameter disappears from the cycle parameters when the "auto start" function is applied.

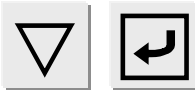
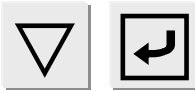
 Select the option and enter settings if necessary.

|                                                                                                                                                                                  |                                                                                     |                                                                                                               |
|----------------------------------------------------------------------------------------------------------------------------------------------------------------------------------|-------------------------------------------------------------------------------------|---------------------------------------------------------------------------------------------------------------|
| <p>First of all, check or validate in the <b>CONFIGURATION</b> menu the <b>START AUTO</b> function.</p>                                                                          |    | <pre>CONF1/EXTENDED MENUS VALVE CODES : Yes RECUP THRESH : Yes ▶AUTO START  : Yes</pre>                       |
| <p>In the <b>PARAMETERS /FUNCTIONS</b> menu of the program, validate the <b>AUTO START</b> function.</p>                                                                         |    | <pre>ARAM/Pr:001/FUNCTIONS VALVE CODES : No ▶AUTO START  : Yes RECUP THRESH : Yes</pre>                       |
| <p>Return to the test cycle screen by pressing on the "C" several times.</p>                                                                                                     |  | <pre>CYCLE/Pr: 001 PRESS = 150.0 mbar  READY</pre>                                                            |
| <p>Press the "RESET" key to initialise the instrument. In this way, the instrument launches a reset cycle.</p>                                                                   |  | <pre>CYCLE/Pr: 001 PRESS = 150.0 mbar  AUTO ZERO</pre>                                                        |
| <p>Then, if no parts are connected to the measurement circuit, it will display a bar chart &gt;&gt;&gt;&gt;&gt;&gt;&gt;&gt;&gt;&gt;&gt;&gt; indicating the size of the leak.</p> |                                                                                     | <pre>CYCLE/Pr: 001 PRESS = 150.0 mbar LEAK =&gt;&gt;&gt;&gt;&gt;&gt;&gt;&gt;&gt;&gt;&gt;&gt; LARGE LEAK</pre> |
| <p>If a part is connected to the test circuit, the leak decreases. The bar chart diminishes in the same proportions.</p>                                                         |                                                                                     | <pre>CYCLE/Pr: 001 PRESS = 150.0 mbar LEAK =&gt;&gt; LARGE LEAK</pre>                                         |
| <p>When the leak is virtually eliminated, the test cycle starts automatically.</p>                                                                                               |                                                                                     | <pre>CYCLE/Pr: 001 PRESS = 150.0 mbar  FILL</pre>                                                             |

### **2.1.3. 8) Chaining**

This function enables several tests to be carried out by the instrument one after the other.

The instrument offers the option of chaining according to 6 chaining criteria.

Associated parameters to be set: INTER-CYCLE (wait time between two cycles).

Chaining conditions: ALL (under all conditions), PART OK (part good), TEST FAULT (test part bad), WARNING, PRESS ERROR (pressure fault), RECUPERABLE (recoverable parts).

**Note:** *this function is not available in the "Automatic start" mode (Auto start).*

☞ Select the option and enter settings if necessary.

### **2.1.3. 9) Automatic connector**

The automatic connector is a pneumatic control enabling the driving of an external logic (pneumatic sealing connector). This control is activated at the start of the cycle and is released at the end of the cycle (refer to "cycle end" diagram § 2.1.3.11)

If several programs are chained, the automatic connectors are activated according to the times set as parameters in the first program and are deactivated according to the times set as parameters in the last program in the chain.

They remain active throughout all cycles between the first and last program in the chain.

The various waiting times A are applied in the programs in between.

Associated parameters to be set: WAIT A, WAIT B.

**Note:** *this function is not valid in the "Automatic start" mode (Auto. start).*

☞ Select the option and enter settings if necessary.

### 2.1.3. 10) Stamping function

This option is used to activate a pneumatic output which marks the part (for example using a pneumatic cylinder).

Parameters can be set for the conditions and duration of marking.





This option requires two electrical outputs:

- ✓ an internal one for the internal cabling on the pneumatic output,
- ✓ an external one for "customer" cabling

One of the pneumatic outputs on the automatic connectors is used.

The output is activated at the end of test time for the programmed hold time.

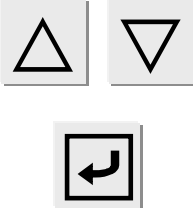
Use the following procedure to use the inking function.

|                                                                                                 |                                                                                     |                                                                                                               |
|-------------------------------------------------------------------------------------------------|-------------------------------------------------------------------------------------|---------------------------------------------------------------------------------------------------------------|
| <p>First, in the <b>CONFIGURATION</b> menu, confirm the <b>STAMPING</b> function.</p>           |    | <pre> CONF/EXTENDED MENU REF. VOLUME : No VOLUME CALC. : No #STAMPING   : Yes                     </pre>      |
| <p>In the program's <b>PARAMETERS/FUNCTIONS</b> menu, confirm the <b>STAMPING</b> function.</p> |   | <pre> ARAM/Pr001/FONCTIONS #STAMPING   : Yes                     </pre>                                       |
| <p>Set the inking hold value (can be set between 0 and 650 seconds).</p>                        |  | <pre> Pr001/FUNCT/STAMPING #MAINTAIN   : 00.5 s ALL         : No OK          : Yes                     </pre> |
| <p>Then select the inking conditions from those offered.</p>                                    |  | <pre> Pr001/FUNCT/STAMPING MAINTAIN   : 00.5 s ALL         : No #OK        : Yes                     </pre>   |

When the instrument is fitted with this option, the internal and external valve codes 1 are no longer available.

**Note:** this function is not valid in the "**Automatic start**" mode (Auto start).



 Select the option and enter settings if necessary.

**2.1.3. 11) Cycle end**

This function allows the selection of different cycle ends depending on the configuration of the instrument (connection to a PLC...).

**a) Relay sequencing depending on the varying cycle ends**

In the aim of networking the **ATEQ G520** with its environment (PLC, PC ...), the following timing charts supply the sequencing of the electrical outputs (relay boards on the J3 connector) and pneumatic outputs (automatic connectors), depending on the commands entered on the front facia or the J3 connector (START, RESET).

| Legend                     |                                                                                                                                                                                                     |
|----------------------------|-----------------------------------------------------------------------------------------------------------------------------------------------------------------------------------------------------|
| <b>A</b>                   | Automatic connector wait time A                                                                                                                                                                     |
| <b>B</b>                   | Automatic connector wait time B                                                                                                                                                                     |
| <b>P - F</b>               | Pre-fill time                                                                                                                                                                                       |
| <b>F</b>                   | Fill time                                                                                                                                                                                           |
| <b>S</b>                   | Stabilization time                                                                                                                                                                                  |
| <b>#</b>                   | Undetermined time which comes into play at the end of the programmed test time and activation of the  Reset key. |
| <b>T</b>                   | Test time                                                                                                                                                                                           |
| <b>D</b>                   | Dump time                                                                                                                                                                                           |
| <b>START</b>               | Activation of the  key on the front facia or contact between pins 2 and 3 of the J3 connector                    |
| <b>RESET</b>               | Activation of the  key on the front facia or contact between pins 1 and 2 of the J3 connector.                   |
| <b>Automatic connector</b> | Active (high level): the pneumatic output is active (air exiting)<br>Inactive (low level): the pneumatic output is inactive (absence of air)                                                        |
| <b>PG or PB</b>            | Good or Bad Part relay on the J3 connector                                                                                                                                                          |
| <b>EoC</b>                 | End of cycle relay on the J3 connector                                                                                                                                                              |
| <b>t mini</b>              | Minimum take into account time on an input, 500 ms on the J8 connector of a central module and 50ms on the J3 connector of a measurement head.                                                      |

 **The time scale is not respected, however the indications regarding time are correct.**

**b) « Automatic RESET » cycle end (systematic reset)**

If the part is OK, the Part OK relay will be activated as soon as the test ends and remain so until the start of the following cycle. Following the dump time, the end of cycle relay is activated (or after the wait time B if the value is not naught).

If the part is bad, the bad part relay is activated as soon as the test is completed. The instrument automatically dumps and sends a cycle end signal. A new cycle can then be launched.

Example with optional external pre-fill and dump:

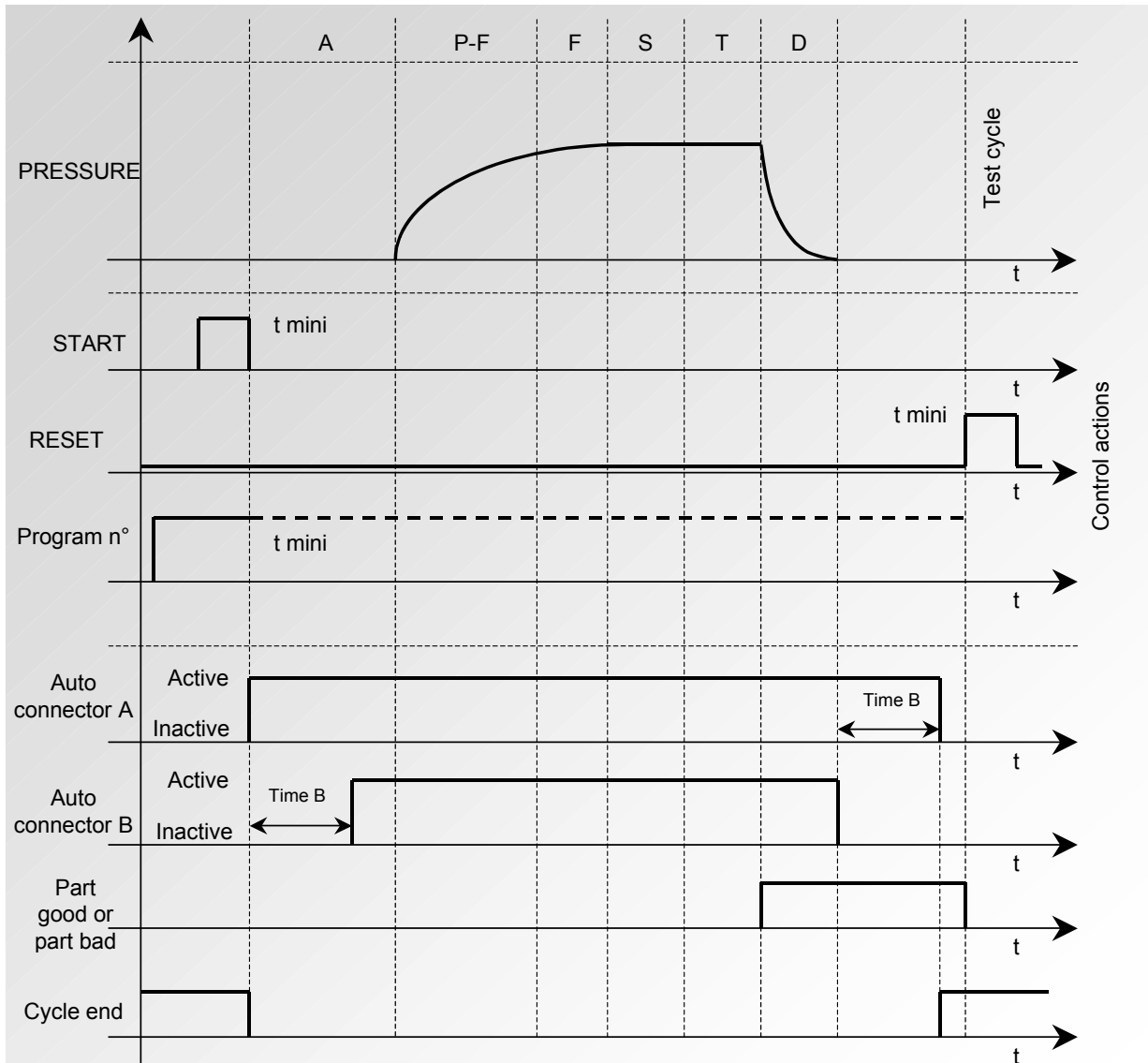

The active program is the one selected before starting up. It remains active even if the program inputs on the connector are no longer activated. This selection can only be modified during the inter cycle period.

To return to program 1, when a cycle is not in progress, press any of the program selection inputs.

**c) Ending a cycle with the RESET key (« Automatic RESET »  
Cycle end)**

Example with optional external pre-fill and dump:

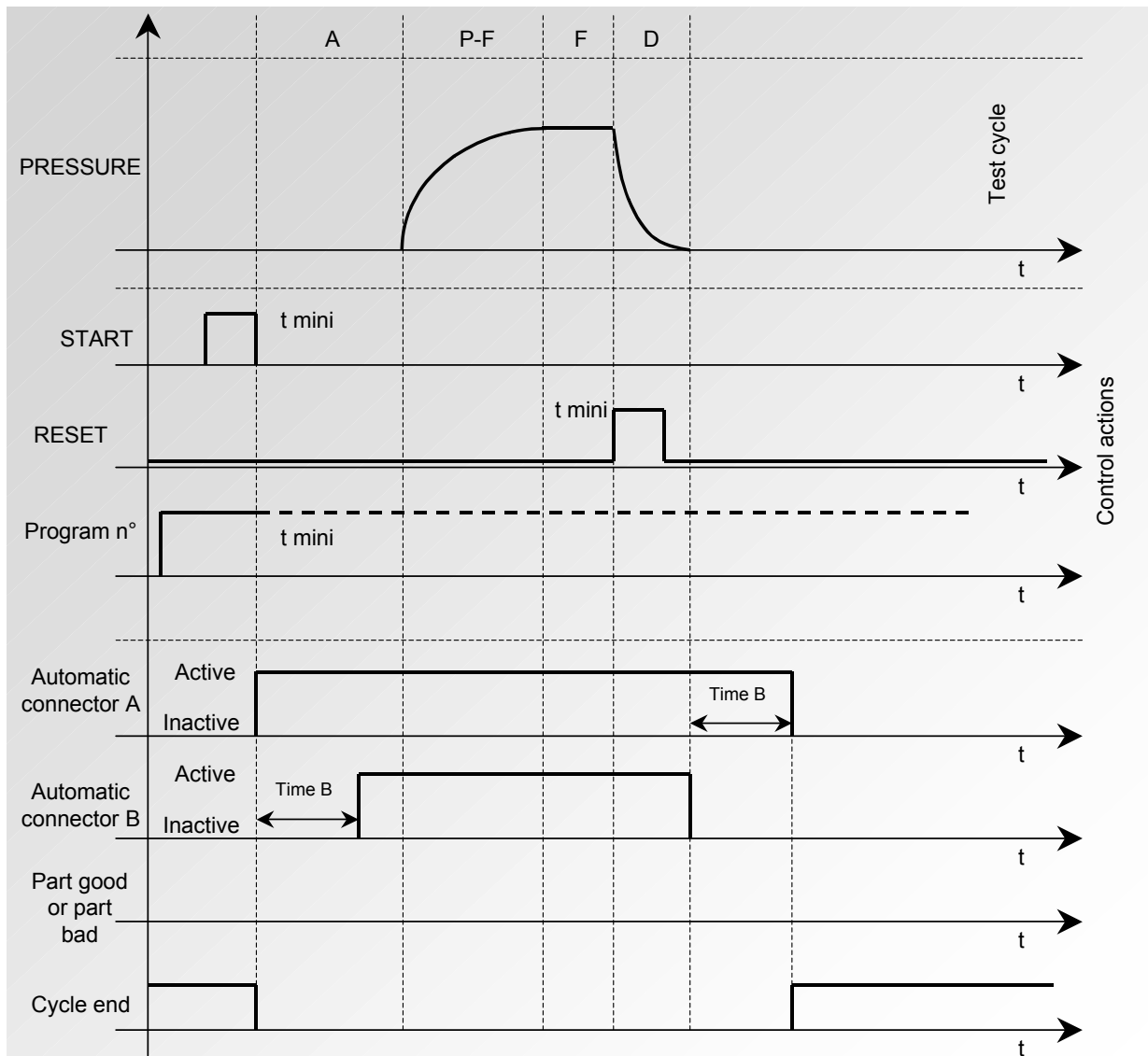

The active program is the one selected before starting up. It remains active even if the program inputs on the connector are no longer activated. This selection can only be modified during the inter cycle period.

To return to program 1, when a cycle is not in progress, press any of the program selection inputs.

**d) « RESET + dump » cycle end (automatic dump)**

If the part is OK, the part OK relay is activated as soon as the test time is finished, and remains so (only in position 2) until the next cycle is launched.

At the end of the dump time, the end of cycle relay is activated.

If the part is Bad, as soon as the test time is over, the bad part relay is activated and remains so until the end of the cycle. The dump is then carried out. The cycle can be

ended by pressing the **RESET**  key.

Example with optional external pre-fill and dump:

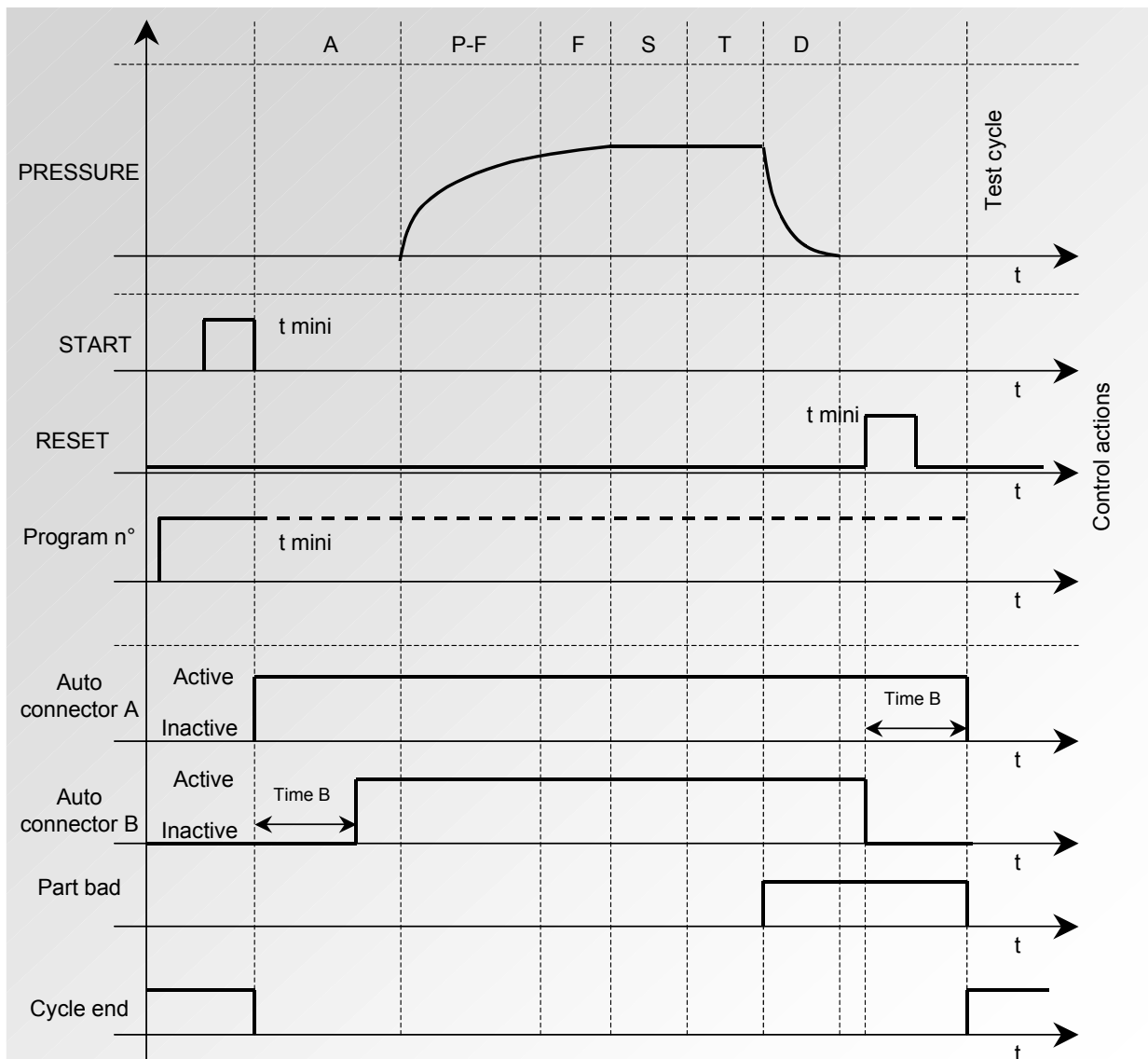

The active program is the one selected before starting up. It remains active even if the program inputs on the connector are no longer activated. This selection can only be modified during the inter cycle period.

To return to program 1, when a cycle is not in progress, press any of the program selection inputs.

e) « Fill » cycle end

If the part is OK, the good part relay is activated at the end of the test time and remains so till the start of the next cycle.

At the end of the dump time, the end of cycle relay is activated (or after the wait time B if the value is not naught).

If the part is bad, as soon as the test time is finished the relay becomes and remains activated.

The instrument waits for a reset from the operator or the PLC to start the dump time and send the end of cycle signal.

Example with optional external pre-fill and dump:

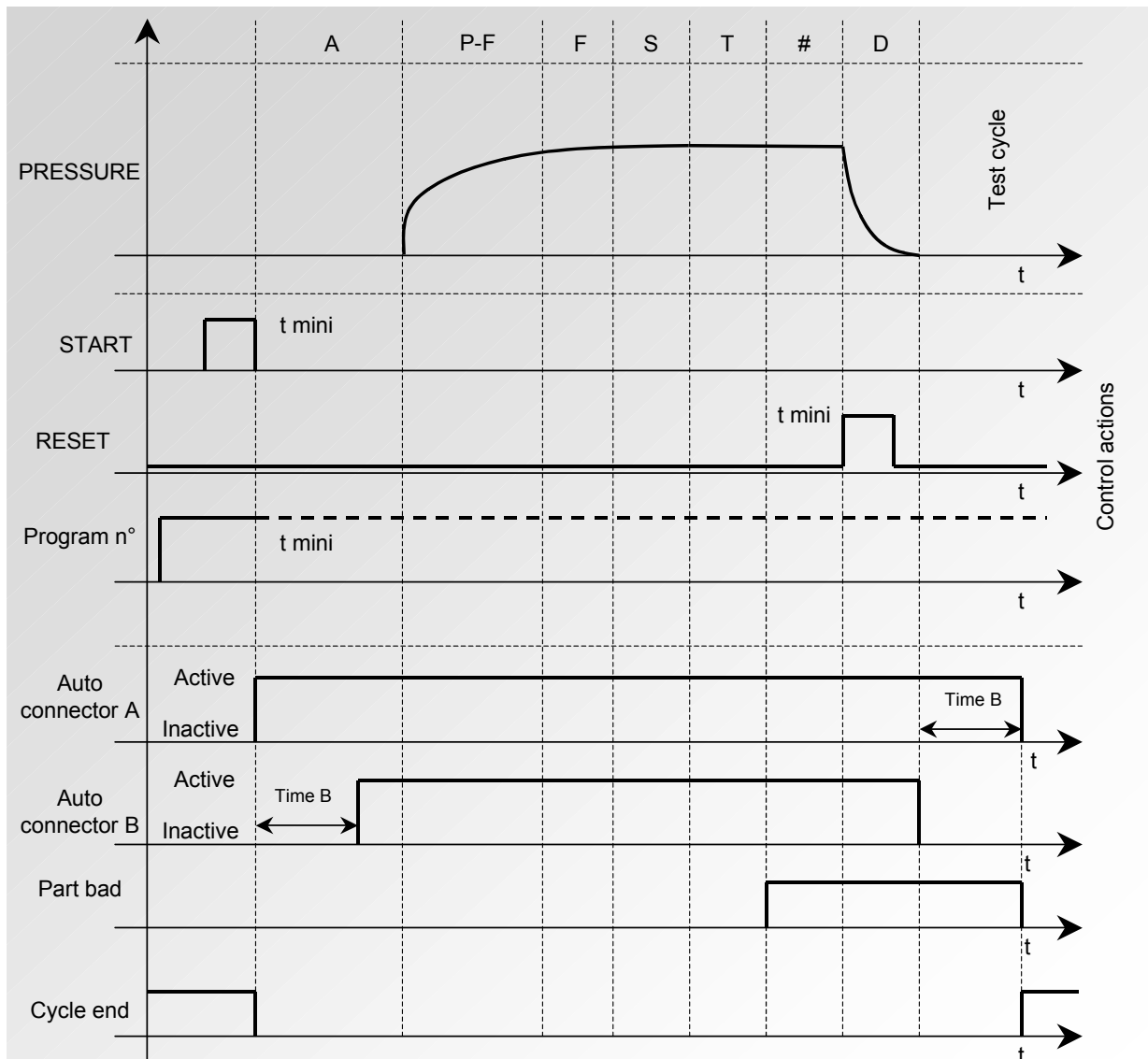

## 2.1.3. 12) Cycle timing chart with stamping and dumping

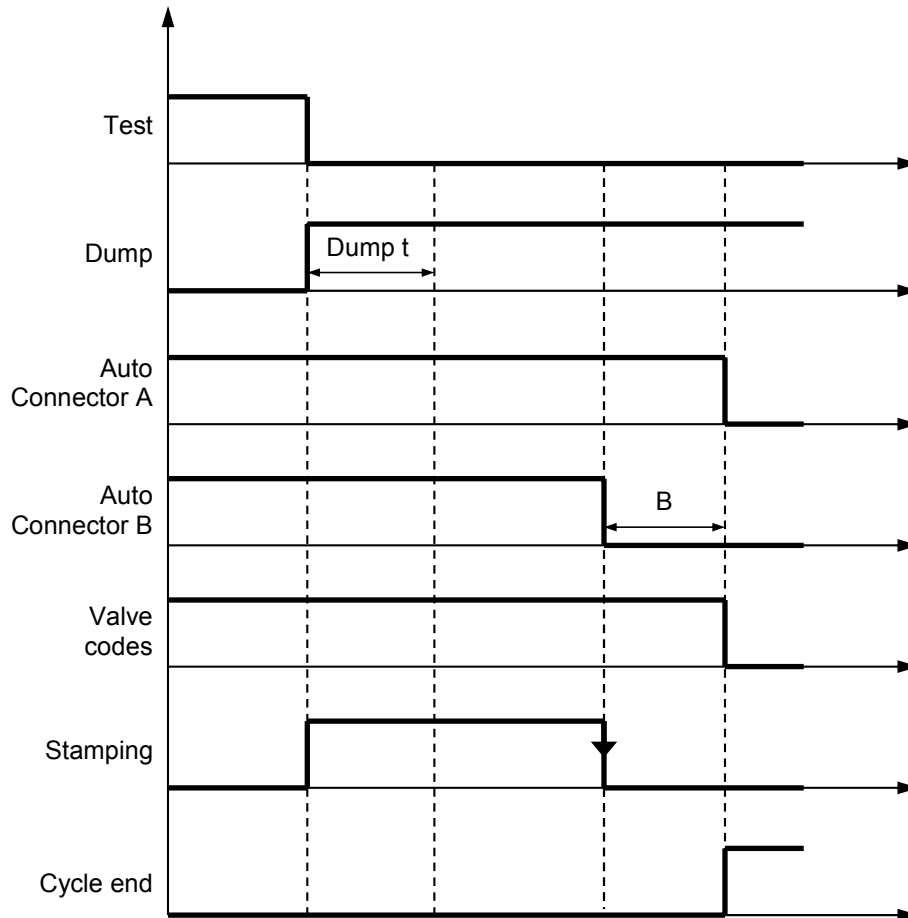

In the above example it's the stamping time superior than the dumping time who initiates the end of the cycle, otherwise the dumping time initiates the end of cycle.

## 2.1.3. 13) Fill mode

This function allows the choice of one of three possible types of fill.

**Note:** this function is not valid in the "Automatic start" mode (Auto start).

☞ Select the option and enter settings if necessary.

## a) Standard

Carries out the fill time whilst monitoring the pressure thresholds..

## b) Inbstruction

When the instructed pressure is reached, the filling is stopped and the instrument moves on to the next stage of the cycle.

## c) Ballistic

This type of fill allows for a fluctuation of the air pressure (filling of parts with important deformations) and notably allows the overshooting of the maximum fill threshold without stopping the cycle and delivering an error message. Never the less, to switch to stabilization, the test pressure will have to be within the thresholds once the filling is complete.

### 2.1.3. 14) Type of Pre-fill

The type of pre-fill function is used to test large volume parts: to fill the part faster, allowing for a reduction in the cycle time. The regulator output is directly linked to the test output.

Insertion of the pre-fill time in the measurement cycle.

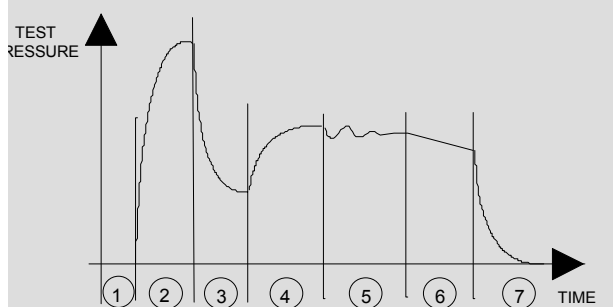

- 1) Wait,
- 2) Pre-fill,
- 3) Fill,
- 4) Stabilization,
- 5) Test,
- 6) Dump.

**NB:** this function is not valid in the "Automatic start" mode (Auto start).

☞ Select the option and enter settings if necessary.

#### a) Standard

Carries out the pre-fill in the programmed time.

#### b) Instruction

Not operational.

#### c) Ballistic

Not operational.

☞ Select the option and enter settings if necessary.

### 2.1.3. 15) Volume calculation

If a flow type unit is used, the parameter must be set for the total test volume. The "Volume calculation" function allows its determination and setting in the parameters

#### Preparation of the instrument

- ✓ Connect to the instrument a part with no leak.
- ✓ Connect a known standard leak to the rapid connector on the instrument's measurement circuit. .
- ✓ Adjust the test pressure of the calibration leak.
- ✓ Run a special "Calc. vol." cycle by entering the value of the leak in the "INSTRUCT." line.
- ✓ Carry out the special "Volume calculation" cycle. At the end, by pressing on the "Enter" key, the volume value will be displayed.
- ✓ The value of the volume is updated automatically within the active program.

## 2.2. AUTOMATIC SAVE

This function has for main objective to save the test parameters from the RAM memory of the instrument to its flash memory.

When this function is not validated, each time the key switch is turned from the **ACCESS** to the **LOCKED** mode, the instrument displays **NO PARAMETERS SAVED IN FLASH**. The save operation can be carried out manually in the **SERVICE PARAMETERS** menu.





When the **AUTOMATIC SAVE** function is confirmed with a **YES**, the parameters are saved automatically when the key is turned from the **ACCESS** to the **LOCKED** position.

This function is useful if the parameters in the RAM are accidentally erased. The instrument will then automatically read and restore the flash parameters in the RAM.

## 2.3. PIEZO AUTO ZERO

This function enables the setting of the frequency or of the number of measurement cycles between two Piezo auto zeros.

➤ **"Frequency" counter**: to set a time space between two auto zeros of 1 to 999 minutes. When the dial is on zero, no auto-zero is carried out.

|                                                                                           |                                                                                                                                                                         |                                                                      |
|-------------------------------------------------------------------------------------------|-------------------------------------------------------------------------------------------------------------------------------------------------------------------------|----------------------------------------------------------------------|
| <p>Confirm with <b>Yes</b> the <b>PIEZO AUTO AZ</b> in the <b>Configuration</b> menu.</p> |   | <pre>MAIN/CONFIGURATION REGUL. CTRL : Ext. ▶PIEZO AUTO AZ: Yes</pre> |
| <p>Then, enter the frequency parameter and/or number of cycles.</p>                       |   | <pre>/CONFI/PIEZO AUTO AZ ▶FREQUENCY : 05</pre>                      |

☞ Select the option and enter settings if necessary.

## 2.4. BAR GRAPH

This function is able only with a RC5 remote control or if the instrument possesses a 14 characters L.E.D. display.

It allows having the flow value on a graphic display with a scale in regards of the captured reject thresholds.

On the inferior scale is the programmable reject threshold at 30, 50 or 70 % of the display.

On the superior scale is the current flow value.



Select the option and enter settings if necessary.

## 2.5. HOUR

This function includes a clock (hours, minutes) and an internal calendar (day, month, year).

Select the option and enter settings if necessary.

## 2.6. RS232

### 2.6.1. C540/580

This function enables the configuration of the instrument so that it may be supervised by an ATEQ central module.

Select the option and enter settings if necessary.

#### 2.6.1. 1) Print frame

Not operational.

### 2.6.2. Printer

This function enables the configuration of the instrument to enable the printing of the program data (parameters) as well as the test results. When the option is activated (YES), each time a cycle is started, the test results are systematically printed.

Select the option and enter settings if necessary.

#### 2.6.2. 1) RS parameters

These parameters enable the configuration of the instrument enabling it to communicate with the printer.

Associated parameters to be set: Speed, Stop byte, number of data bytes, parity.

Select the option and enter settings if necessary.

### 2.6.2. 2) Print frame

This function enables the configuration of the results printout.

Associated parameters to be set: PRESSURE (Display or not of the test pressure), Prog. name (Display of the program name when set), Date & Time (printing of the date and the time), Lines before (number of lines before the result), Lines after (number of lines after the result), Inter line (space between each line), Form feed (new page).

#### a) Frame format

The results frame is based on 40 columns.

- **Example for test OK result**

```

1 2 3 4 5 6 7 8 9 10 11 12 13 14 15 16 17 18 19 20 21 22 23 24 25 26 27 28 29 30 31 32 33 34 35 36 37 38 39 40
< 0 1 > :      9 7 . 9   m b a r : ( O K ) :      5 . 7   c m 3 / m n
    
```

Frame detail :

| Columns | Characters                                               |
|---------|----------------------------------------------------------|
| 1       | <                                                        |
| 2-3     | Figure indicating program number                         |
| 4       | >                                                        |
| 5       | :                                                        |
| 6       | space                                                    |
| 7 – 11  | Display of the test pressure                             |
| 12      | space                                                    |
| 13 – 16 | Pressure unit                                            |
| 17      | :                                                        |
| 18      | (                                                        |
| 19 – 20 | 2 letters indicating OK for good part<br>TD for bad part |
| 21      | )                                                        |
| 22      | :                                                        |
| 23      | space                                                    |
| 24 – 27 | Value of the leak measurement                            |
| 28      | space                                                    |
| 29 > XX | 2 to 6 letters indicating the unit                       |

- **Example for a test result with time and date**

```

1 2 3 4 5 6 7 8 9 10 11 12 13 14 15 16 17 18 19 20 21 22 23 24 25 26 27 28 29 30 31 32 33 34 35 36 37 38 39 40
< 0 1 > : 3 0 / 0 5 / 2 0 0 2   1 0 : 4 1 : 1 6
< 0 1 > : 1 0 3 . 1   m b a r : ( O K ) : 3 . 2   c m 3 / m n
    
```



**2.6.2. 4) Exporting**

This function can be used to create and send a special results frame which can be processed by a PC using Microsoft Excel.

This frame is of the same type as the print parameters frame except that the different character strings follow each other and are separated by a punctuation mark which enables the various boxes to be entered automatically in Microsoft Excel.

This frame is operated by connecting a computer to the instrument's RS 232 link.

Columns detail:

- |                           |                               |
|---------------------------|-------------------------------|
| 1) Customization.         | 6) Numeric value of pressure. |
| 2) Program number.        | 7) Pressure unit.             |
| 3) Test result message.   | 8) Alarm message.             |
| 4) Numeric value of test. | 9) Date.                      |
| 5) Test unit.             | 10) Hour.                     |

Exportation example:

**Flow mode:**

| 1    | 2 | 3    | 4    | 5     | 6     | 7    | 8             | 9        | 10       |
|------|---|------|------|-------|-------|------|---------------|----------|----------|
| NAME | 1 | (OK) | 0.0  | cm3/h | 150.0 | mbar |               | 05/06/02 | 13:19:18 |
| NAME | 1 | (OK) | 45.8 | cm3/h | 149.4 | mbar |               | 05/06/02 | 13:20:33 |
| NAME | 1 | (TD) |      |       | 133.6 | mbar | >> F.S. TEST  | 05/06/02 | 13:21:12 |
| NAME | 1 | (TD) | 68.9 | cm3/h | 139.1 | mbar |               | 05/06/02 | 13:21:23 |
| NAME | 1 | (AL) |      |       | 147.6 | mbar | >> F.S. TEST  | 05/06/02 | 13:21:54 |
| NAME | 1 | (AL) |      |       | 149.8 | mbar | >> F.S. REF.  | 05/06/02 | 13:22:06 |
| NAME | 1 | (AL) |      |       | 188.6 | mbar | PRESS. EXCEED | 05/06/02 | 13:25:41 |
| NAME | 1 | (AL) |      |       | 90.9  | mbar | LOW PRESSURE  | 05/06/02 | 13:26:00 |
| NAME | 1 | (AL) |      |       | 0.0   | mbar | P0            | 05/06/02 | 13:26:06 |
| NAME | 1 | (AL) |      |       | 152.6 | mbar | SENSOR        | 05/06/02 | 13:28:02 |
| NAME | 1 | (AL) |      |       |       |      | F.S. piezzo   | 05/06/02 | 13:30:30 |

**Operator mode:**

| 1    | 2 | 3    | 4 | 5 | 6     | 7    | 8 | 9        | 10       |
|------|---|------|---|---|-------|------|---|----------|----------|
| NAME | 5 | (OK) |   |   | 152.2 | mbar |   | 05/06/02 | 13:34:50 |
| NAME | 5 | (TD) |   |   | 152.2 | mbar |   | 05/06/02 | 13:34:53 |

 Select the option and enter settings if necessary.

### 2.6.2. 5) Print parameters

When this option is confirmed the test parameters are printed immediately.

#### a) Example of parameter print frame

| 1 | 2 | 3 | 4 | 5 | 6 | 7 | 8 | 9 | 10 | 11 | 12 | 13 | 14 | 15 | 16 | 17 | 18 | 19 | 20 | 21 | 22 | 23 | 24 | 25 | 26 | 27 | 28 | 29 | 30 | 31 | 32 | 33 | 34 | 35 | 36 | 37 | 38 | 39 | 40 |  |
|---|---|---|---|---|---|---|---|---|----|----|----|----|----|----|----|----|----|----|----|----|----|----|----|----|----|----|----|----|----|----|----|----|----|----|----|----|----|----|----|--|
| V | e | r | s | i | o | n |   | 0 | 1  | .  | 0  | 0  | j  |    |    |    |    |    |    |    |    |    |    |    |    |    |    |    |    |    |    |    |    |    |    |    |    |    |    |  |
| 3 | . | 1 | / | 0 | 5 | / | 2 | 0 | 0  | 2  |    |    |    |    |    |    |    |    |    |    |    |    |    |    |    |    |    |    |    |    |    |    |    |    |    |    |    |    |    |  |
| P | r |   | 0 | 1 |   |   |   |   |    |    |    |    |    |    |    |    |    |    |    |    |    |    |    |    |    |    |    |    |    |    |    |    |    |    |    |    |    |    |    |  |
| T | Y | P | E |   | : |   | F | L | O  | W  |    | T  | E  | S  | T  |    |    |    |    |    |    |    |    |    |    |    |    |    |    |    |    |    |    |    |    |    |    |    |    |  |
| W | A | I | T |   | A |   | : |   | 0  | 0  | .  | 1  |    | s  |    |    |    |    |    |    |    |    |    |    |    |    |    |    |    |    |    |    |    |    |    |    |    |    |    |  |
| F | I | L | L |   | : |   | 0 | 1 | .  | 0  |    | s  |    |    |    |    |    |    |    |    |    |    |    |    |    |    |    |    |    |    |    |    |    |    |    |    |    |    |    |  |
| S | T | A | B |   | : |   | 0 | 1 | .  | 0  |    | s  |    |    |    |    |    |    |    |    |    |    |    |    |    |    |    |    |    |    |    |    |    |    |    |    |    |    |    |  |
| T | E | S | T |   | : |   | 0 | 2 | .  | 0  |    | s  |    |    |    |    |    |    |    |    |    |    |    |    |    |    |    |    |    |    |    |    |    |    |    |    |    |    |    |  |
| P | r | e | s | s | . | U | N | I | T  |    | :  | m  | b  | a  | r  |    |    |    |    |    |    |    |    |    |    |    |    |    |    |    |    |    |    |    |    |    |    |    |    |  |
| I | N | S | T | R | U | C | T |   | :  |    | 1  | 5  | 0  | .  | 0  |    |    |    |    |    |    |    |    |    |    |    |    |    |    |    |    |    |    |    |    |    |    |    |    |  |
| M | a | x |   | F | I | L | L |   | :  |    | 1  | 8  | 0  | .  | 0  |    |    |    |    |    |    |    |    |    |    |    |    |    |    |    |    |    |    |    |    |    |    |    |    |  |
| M | i | n |   | F | I | L | L |   | :  |    | 1  | 2  | 0  | .  | 0  |    |    |    |    |    |    |    |    |    |    |    |    |    |    |    |    |    |    |    |    |    |    |    |    |  |
| R |   | U | N | I | T |   | : |   | c  | m  | 3  | /  | m  | n  |    |    |    |    |    |    |    |    |    |    |    |    |    |    |    |    |    |    |    |    |    |    |    |    |    |  |
| V | O | L | U | M | E |   | : |   | 0  | .  | 0  | 0  | 7  |    | L  |    |    |    |    |    |    |    |    |    |    |    |    |    |    |    |    |    |    |    |    |    |    |    |    |  |
| T | e | s | t |   | R | E | J | E | C  | T  | :  |    | 0  | 1  | 0  |    |    |    |    |    |    |    |    |    |    |    |    |    |    |    |    |    |    |    |    |    |    |    |    |  |

### 2.6.3. Modbus

This function enables the configuration of the Modbus link when the instrument is installed in this type of network. The address of the station is fixed at 255, the frame parameters and RS parameters (speed, serial port) must be entered. See the Modbus ATEQ specific manual

☞ Select the option and enter settings if necessary.

## 2.7. RS485

### 2.7.1. C540/580

This function allows configuring the RS485 output to a C540 or F580 central when the instrument is installed in a network.

☞ Select the option and enter settings if necessary.

### 2.7.2. Modbus

This function allows configuring a Modbus link when the instrument is in this kind of network. The station address, RS parameters (speed, serial port) are to be informed. See the specific ATEQ Modbus user manual.

☞ Select the option and enter settings if necessary.

## 2.8. SECURITY

This function deactivates the **START** and **RESET** keys on the instrument front panel. Programs can only be started from the instrument inputs (J3 connector).

☞ Select the option and enter settings if necessary.





## 2.9. LIGHTING THE SCREEN



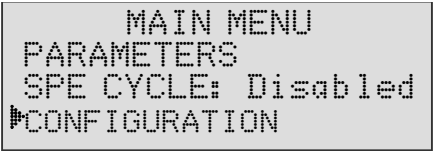

Screen illumination can be programmed and modified. The lighting can be adjusted according to the ambient conditions or the user's choice.

There are three lighting modes:

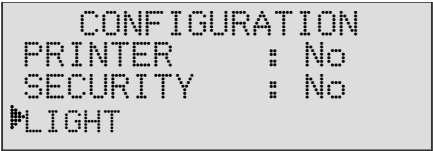
- ✓ **continuous** mode, display screen permanently lit whatever the conditions,
- ✓ **manual** mode, the screen remains lit for 20 minutes and if the keyboard has not been used by the end of this period the screen shuts down and only relights when the keyboard is touched again,
- ✓ **automatic** mode, which is identical to manual mode, with illumination of the screen also if an action is carried out from the external inputs (rear connectors).

Using these three modes, the lighting intensity of the screen can be programmed from 00 (screen off) to 07 (maximum lighting intensity).

|                                                                                                                      |                                                                                                                                                                         |                                                                                      |
|----------------------------------------------------------------------------------------------------------------------|-------------------------------------------------------------------------------------------------------------------------------------------------------------------------|--------------------------------------------------------------------------------------|
| <p>In the main menu, position the cursor by the <b>CONFIGURATION</b> menu then confirm by pressing <b>ENTER</b>.</p> |   |  |
| <p>Move the cursor down until it is in front of the <b>LIGHT</b> menu then confirm by pressing <b>ENTER</b>.</p>     |   |  |

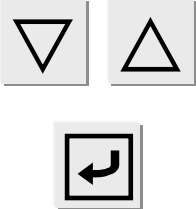
|                                                                                                                                                                       |                                                                                    |                                                                     |
|-----------------------------------------------------------------------------------------------------------------------------------------------------------------------|------------------------------------------------------------------------------------|---------------------------------------------------------------------|
| <p>Place the cursor in front of <b>MODE</b> to choose the required lighting mode and confirm using <b>ENTER</b>.</p>                                                  |   | <pre> CONF/LIGHT MODE      : CONTINOU INTENSITY : 04         </pre> |
| <p>Select the lighting mode and confirm using <b>ENTER</b>.</p>                                                                                                       |   | <pre> CONF/LIGHT/MODE CONTINUOUS MANUAL AUTO         </pre>         |
| <p>To return to the previous menu, press the <b>C</b> button once</p>                                                                                                 |   | <pre> CONF/LIGHT MODE      : PERMANEN INTENSITY : 07         </pre> |
| <p>To select the lighting intensity for the display, place the cursor in front of the <b>INTENSITY</b> menu and confirm using <b>ENTER</b>.</p>                       |   | <pre> CONF/LIGHT MODE      : CONTINOU INTENSITY : 04         </pre> |
| <p>Then select the lighting intensity from 00 (off) to 07 (maximum luminosity) and the new lighting intensity will be applied as soon as <b>ENTER</b> is pressed.</p> |  | <pre> CONF/LIGHT MODE      : CONTINOU INTENSITY : 06         </pre> |

### 2.10. EXTERNAL DUMP OPTION



This option can be used to control a dump valve outside the instrument (for example: a remote Y valve).



External dumping enables the part to be emptied before it is disconnected if the test pressure is too high.

This option requires two electrical outputs:

- ✓ an internal one for internal cabling the pneumatic output,
- ✓ an external one for "customer" cabling.

Use the following procedure to use the external dump function.

|                                                                                                                     |                                                                                     |                                                                                    |
|---------------------------------------------------------------------------------------------------------------------|-------------------------------------------------------------------------------------|------------------------------------------------------------------------------------|
| <p>First, check or confirm the <b>EXTERNAL DUMP</b> function in the <b>CONFIGURATION</b> menu.</p>                  |  | <pre> CONFIGURATION LIGHTING STAMPING      : Yes EXT. DUMP     : No         </pre> |
| <p>After confirming the function, select the mode for the dump valve, <b>NORM. OPEN</b> or <b>NORM. CLOSED</b>.</p> |  | <pre> CONF/EXT. DUMP NORM. CLOSED NORM. OPEN         </pre>                        |

|                                                                                                                                                                   |                                                                                   |                                                                                                                 |
|-------------------------------------------------------------------------------------------------------------------------------------------------------------------|-----------------------------------------------------------------------------------|-----------------------------------------------------------------------------------------------------------------|
| <p>Then in the <b>PARAMETERS / FUNCTIONS</b> menu, confirm the <b>EXT. DUMP</b> function and at each end of cycle the external dump output will be activated.</p> |  | <pre> ARAM/Pr001/FUNCTIONS BLOW MODE      : No STAMPING       : Yes EXT. DUMP      : Yes                 </pre> |
| <p>Then, set the parameter the dump time (time during which the dump valve is open)</p>                                                                           |  | <pre> M/Pr001/FUNCT/DUMP DUMP           : 03.0 s                 </pre>                                         |

If the instrument is fitted with this option, internal and external valve codes 2 are no longer available.

### 2.11. SHUT OFF (OPTION)

The "Cut off" option when it's installed in the instrument and validate, allows to driving an external valve.

This external valve stops the air or gas flow when the instrument is out of cycle measurement.

This option needs two electrical outputs:

- ✓ one for the internal cabling of the pneumatic output,
- ✓ one external for the "customer" cabling.

For the bringing into service of the "Cut off" function follow the following procedure:

|                                                                        |                                                                                     |                                                                                             |
|------------------------------------------------------------------------|-------------------------------------------------------------------------------------|---------------------------------------------------------------------------------------------|
| <p>Validate the function in the <b>CONFIGURATION/CUT OFF</b> menu.</p> |  | <pre> CONFIGURATION LIGHTING EXT. DUMP      : No SHUT OFF      : Yes                 </pre> |
|------------------------------------------------------------------------|-------------------------------------------------------------------------------------|---------------------------------------------------------------------------------------------|

When the instrument possesses this function, the valves codes 2 internal and external are not available.

When this function is installed in the instrument, the "External dump" can't be installed.

### 2.12. NEGATIVE FLOW ALARM

A negative flow can be brought on by the instability of the part to be tested or by an internal leak of the instrument air chest side. More the volume to be tested is small, more the thresholds will be small and more the volumes are big and more the thresholds will be big (the measurement more difficult in this case).

The advised values are: maximum threshold at 30 % for volumes smaller than 150 cm<sup>3</sup> and maximum threshold at 100 % for volumes bigger than 150 cm<sup>3</sup>. The percentage can be eventually being reduced to the minimum just before having the fault following the instability of the part to be tested.

In the event of negative flow, two reject thresholds are set (factory settings) these thresholds show the state of the negative flow on the display.

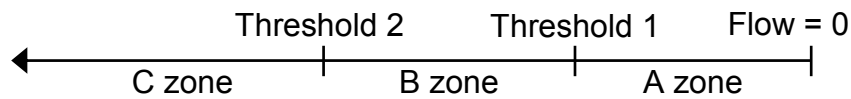

The thresholds mark three zones:

- ✓ **A zone:** 0 ml/h is displayed and the green indicator is permanently lit,
- ✓ **B zone:** 0 ml/h is displayed and the green indicator flashes,
- ✓ **C zone:** The "F. S. REF" alarm is displayed (the two red indicators are lit).

The thresholds set in the factory are 5 % and 30 % or 30 % and 100 % of the full scale (respectively for thresholds 1 and 2).

### 2.13. I/O CONFIGURATION

This menu is used to configure programmable input 7 on connector J3 on the 16-program input/output board.



See the: chapter 1, paragraph 3.1.10.2) "J10 Connector (Inputs/Outputs) programmable input".

### 3. SPECIAL CYCLES MENU

#### 3.1. SPECIAL CYCLES AVAILABLE

The following list shows all the special cycles which are possible: those available will vary depending on what is checked in the extended menus or according to the optional extras requested at the time of manufacture of the instrument.

| Special cycle             | Function                                                                                   |
|---------------------------|--------------------------------------------------------------------------------------------|
| ✓ Inactive                | No special cycle selected.                                                                 |
| ✓ Volume calculation      | Cycle which enables the calculation of the volume of the test circuit.                     |
| ✓ Infinite fill:          | Cycle used to put test part under pressure for infinite time.                              |
| ✓ Piezo auto reset:       | Cycle used to carry out forced reset of the piezo transducer and the electronic regulator. |
| ✓ Print:                  | This cycle allows to send on the RS232 link the last results measured by the instrument.   |
| ✓ Atmospheric conditions: | This cycle allows displaying the atmospheric conditions measured by the instrument.        |





To run a special cycle, select it in the "special cycles" menu, then press the  button. To stop it, press the  button. In some cycles the stop is automatic.

### 3.2. VOLUME CALCULATION

This special cycle enables the calculation of the test circuit volume.

#### Preparation of the instrument





- ✓ Connect the instrument to a part with no leak.
- ✓ Connect a calibration leak on the rapid connector of the instruments test circuit.
- ✓ Adjust the test pressure of the calibration leak.
- ✓ Carry out the "**Volume calculation**" special cycle, setting the leak value in the "**INSTRUCTION**" line of the menu.
- ✓ Start the special volume calculation cycle. At the end of the cycle, by pressing on the "**ENTER**" key the value of the volume is displayed.
- ✓ In the active program, the value of the volume is automatically updated.

|                                                                                                                                                                                                                       |                                                                                     |                                                                                                        |
|-----------------------------------------------------------------------------------------------------------------------------------------------------------------------------------------------------------------------|-------------------------------------------------------------------------------------|--------------------------------------------------------------------------------------------------------|
| <p>In the main menu, place the cursor in front of <b>SPE CYCLE</b> and validate with the <b>ENTER</b> key.</p>                                                                                                        |    | <pre> MAIN MENU ACTIVE PROG. : 001 PARAMETERS ▶ SPE CYCLE: Inactive                     </pre>         |
| <p>Next, place the cursor in front of <b>Volume Calcul.</b> and validate with the <b>ENTER</b> key.</p>                                                                                                               |  | <pre> SPE CYCLE Inactive ▶ VOLUME CALCUL. Piezo auto zero                     </pre>                   |
| <p>The display confirms that the special cycle is selected.<br/>Enter the value of the calibration leak in the <b>INSTRUCT.</b> line(calibration instruction), by using the navigation keys.</p>                      |  | <pre> CYCLE/VOL. CALC. INSTRUCT. : 0.54 INSTRUCT.P : 150.0 R. UNIT : cm3/mn                     </pre> |
| <p>Validate with the <b>ENTER</b> key.</p>                                                                                                                                                                            |  | <pre> MAIN MENU ACTIVE PROG.: 001 PARAMETERS SPE CYCLE : Volume                     </pre>             |
| <p>Press on the <b>START</b> key to launch the special cycle. At the end of the cycle, the calculated value of the volume of the part is sent directly in the active program menu to the <b>VOLUME</b> parameter.</p> |  | <pre> CYCLE/Pr : 001 PRESS = 150.0 mbar FLOW = 0.3 cm3/h TEST                     </pre>               |
| <p>By pressing on the <b>ENTER</b> key, the calculated value of the volume is displayed.</p>                                                                                                                          |                                                                                     | <pre> VOLUME ▶ VOLUME : 0.275 L                     </pre>                                             |

### 3.3. INFINITE FILL

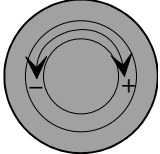

In presence of "shut-off" valve or external dump valve, it is possible to carry out an infinite fill with the instrument, in other words, a permanent flow of air at the test pressure in order to locate leaks (set-up adjustment...).

If the assembly allows it (risk of sudden disconnection of part under pressure) it is preferable, in the case of infinite fill, to have a dump time of zero so as not to draw in liquid if there is a leak (when looking for leaks using a soapy water based product).

|                                                                                                                                                           |                                                                                     |                                                                                            |
|-----------------------------------------------------------------------------------------------------------------------------------------------------------|-------------------------------------------------------------------------------------|--------------------------------------------------------------------------------------------|
| <p>In the main menu, place the cursor in front of the <b>SPE CYCLE</b> function and confirm using the <b>ENTER</b> key.</p>                               |    | <pre> MAIN MENU CYCLE PROG. : 01 PARAMETERS SPE CYCLE: none                     </pre>     |
| <p>Next, place the cursor in front of <b>Infinite fill</b> and confirm using the <b>ENTER</b> key.</p>                                                    |    | <pre> SPE CYCLE Regul. 1 adjust Regul. 2 adjust Infinite fill                     </pre>   |
| <p>The display confirms that the special cycle has been selected.</p>                                                                                     |                                                                                     | <pre> MAIN MENU RUN PROG.   : 01 PARAMETERS SPE CYCLE: Inf fill                     </pre> |
| <p>Press the <b>START</b> key to start a new cycle.</p>                                                                                                   |  | <pre> RUN/Pr : 001 PRESS = 355.5 mbar  FILL                     </pre>                     |
| <p>In case of installation with a mechanical regulator, adjust the test pressure with the regulator.</p>                                                  |  | <pre> RUN/Pr : 001 PRESS = 1000 mbar  FILL                     </pre>                      |
| <p>In case of installation with a electronic regulator, adjust the test pressure with the regulator by pressing the <b>UP</b> and <b>DOWN</b> arrows.</p> |  | <pre> RUN/Pr : 001 PRESS = 1000 mbar  FILL                     </pre>                      |
| <p>To stop the cycle, press the <b>RESET</b> key.</p>                                                                                                     |  | <pre> RUN/Pr : 001 PRESS = 1.00 bar  READY                     </pre>                      |

### 3.4. PIEZO AUTO ZERO

Used for compulsory reset to zero of the piezo sensor.

|                                                                                                        |                                                                                    |                                                                                           |
|--------------------------------------------------------------------------------------------------------|------------------------------------------------------------------------------------|-------------------------------------------------------------------------------------------|
| <p>In the main menu, place the cursor in front of <b>SPE CYCLE</b> and confirm using <b>ENTER</b>.</p> |   | <pre> MAIN MENU RUN PROG: 001 PARAMETERS ▶SPE CYCLE: Inactive                     </pre>  |
| <p>Next, place the cursor in front of <b>Piezo Reset</b> function and confirm using <b>ENTER</b>.</p>  |   | <pre> SPE CYCLE Pre-regul. adjust Infinite fill ▶Piezo reset                     </pre>   |
| <p>The display confirms that the special cycle has been selected.</p>                                  |                                                                                    | <pre> MAIN MENU RUN PROG.: 001 PARAMETERS ▶SPE CYCLE: Piezo R.                     </pre> |
| <p>Press the <b>START</b> key to start the reset.</p>                                                  |  | <pre> RUN/Pr : 001 PRESS = 355.5 mbar  RESET                     </pre>                   |
| <p>Once the reset is carried out, the cycle ends automatically.</p>                                    |                                                                                    | <pre> RUN/Pr : 001 PRESS = 355.5 mbar  READY                     </pre>                   |

**Note:** if the time between cycles is too long, the auto zero cycle may be programmed with a frequency in minutes, allowing the initialisation of the sensors in relation to the atmospheric pressure. Pressure is very important for the measurement of flow.



For automatic devices it may be necessary to inhibit the auto zero cycle.

|                                                                                                                |                                                                                     |                                                                                       |
|----------------------------------------------------------------------------------------------------------------|-------------------------------------------------------------------------------------|---------------------------------------------------------------------------------------|
| <p>To inhibit the automatic zero cycle, go to the <b>CONFIGURATION</b> menu then confirm using <b>non</b>.</p> |  | <pre> CONFIGURATION EXTENDED MENUS ▶AZ PIEZO AUTO: No HOUR                     </pre> |
|----------------------------------------------------------------------------------------------------------------|-------------------------------------------------------------------------------------|---------------------------------------------------------------------------------------|

**Attention:** If an auto zero cycle is not carried out regularly, measurement errors may occur and result in false readings for the air tightness of parts.



### 3.5. PRINT

This special cycle allows sending on the RS232 line the frame of the last measurement results.

|                                                                                                                                                    |                                                                                   |                                                                                          |
|----------------------------------------------------------------------------------------------------------------------------------------------------|-----------------------------------------------------------------------------------|------------------------------------------------------------------------------------------|
| <p>In the main menu, place the cursor in front of <b>SPE CYCLE</b> and confirm using <b>ENTER</b>.</p>                                             |  | <pre> MAIN MENU RUN PROG: 001 PARAMETERS ▶SPE CYCLE: Inactive                     </pre> |
| <p>Next, place the cursor in front of <b>Print</b> function and confirm using <b>ENTER</b>.<br/>The frame is instantly send on the RS232 line.</p> |  | <pre> SPE CYCLE Infinite fill Piezo reset ▶Print                     </pre>              |

### 3.6. ATMOSPHERICS CONDITIONS

This cycle allows displaying the atmospheric conditions measured by the instrument. These atmospheric conditions are: atmospheric pressure and ambient temperature of the tested gas.

|                                                                                                          |                                                                                     |                                                                                          |
|----------------------------------------------------------------------------------------------------------|-------------------------------------------------------------------------------------|------------------------------------------------------------------------------------------|
| <p>In the main menu, place the cursor in front of <b>SPE CYCLE</b> and confirm using <b>ENTER</b>.</p>   |  | <pre> MAIN MENU RUN PROG: 001 PARAMETERS ▶SPE CYCLE: Inactive                     </pre> |
| <p>Next, place the cursor in front of <b>Atm conditions</b> function and confirm using <b>ENTER</b>.</p> |  | <pre> CYCLE SPE Piezo reset Print ▶Atm. Conditions                     </pre>            |
| <p>The instrument displays the atmospheric pressure and the measured temperature.</p>                    |                                                                                     | <pre> ATM. CONDITION  ATM PRES.: 1004 hPa TEMPERATURE : 30.0C                     </pre> |
| <p>To stop the cycle, press the RESET key.</p>                                                           |  | <pre> RUN/Pr : 001 PRESS = 1.00 bar  READY                     </pre>                    |

## 4. SERVICE MENU



### 4.1. PARAMETERS SERVICE

This menu is used to manage the memory containing the test cycle parameters.

- ✓ Save maintenance parameters menu: used to save the configuration of the parameters in the current test.
- ✓ Restore maintenance parameters menu: used to restore a previously saved configuration.
- ✓ Erase maintenance parameters menu: used to delete the current configuration.

To access the menu, turn the switch to the **ACCESS** position.

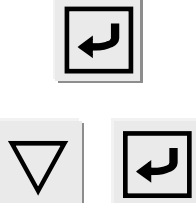

|                                                                                                                                                                                                                                                                                                                             |                                                                                     |                                                                                                    |
|-----------------------------------------------------------------------------------------------------------------------------------------------------------------------------------------------------------------------------------------------------------------------------------------------------------------------------|-------------------------------------------------------------------------------------|----------------------------------------------------------------------------------------------------|
| <p>In the main menu, place the cursor in front of <b>SERVICE</b> and confirm using <b>ENTER</b>.</p>                                                                                                                                                                                                                        |    | <pre> MAIN MENU CYCLE SPE: Disabled CONFIGURATION MAINTENANCE                     </pre>           |
| <p>Then place the cursor in front of <b>PARAMETERS</b> and confirm using <b>ENTER</b>.</p>                                                                                                                                                                                                                                  |  | <pre> MAIN/SERVICE PARAMETERS                     </pre>                                           |
| <p>Then place the cursor in front of the action required :</p> <p><b>SAVE:</b> save current parameters,</p> <p><b>RESTORE:</b> replace current parameters by those stored in the memory,</p> <p><b>ERASE:</b> delete current parameters and return to the initial configuration.</p> <p>and confirm using <b>ENTER</b>.</p> |  | <pre> IN/SERVI/PARAMETER SAVE      : No RESTORE   : No RESET     : No                     </pre>   |
| <p>To activate an operation, confirm using <b>ENTER</b>. Then choose <b>YES</b> using the arrows then confirm again using <b>ENTER</b>.</p>                                                                                                                                                                                 |  | <pre> IN/SERVI/PARAMETERS SAVE      : Yes RESTORE   : No RESET     : No                     </pre> |

Turn the switch to the **LOCK** position.

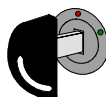

**Note:** if the parameters have been modified, then current and saved parameters are therefore different, when the instrument begins to operate, the following message is displayed on the screen.

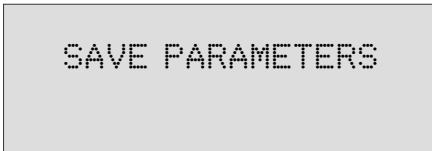



This message is not blocked and will disappear after a few seconds. It informs that a saving of the parameters may be necessary. In this case three solutions arise:

- 1) **Restore** the saved parameters (current parameters will be lost).
- 2) **Save** the current parameters in the memory (the parameters already in the memory will be lost).
- 3) **Do nothing** and work with the current parameters.

#### 4.2. SERVICING OF THE SENSORS

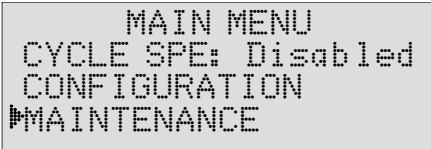
This menu allows the monitoring of the information that is communicated by the pressure sensors, "**PRESSURE**" for the absolute pressure piezo sensor and "**LEAK**" for the differential pressure sensor.

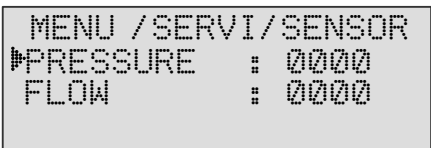
|                                                                                                                         |                                                                                     |                                                                                      |
|-------------------------------------------------------------------------------------------------------------------------|-------------------------------------------------------------------------------------|--------------------------------------------------------------------------------------|
| <p>In the main menu, place the cursor in front of the <b>SERVICE</b> heading and confirm with the <b>ENTER</b> key.</p> |   |   |
| <p>Next, place the cursor in front of <b>SENSORS</b> and confirm with the <b>ENTER</b> key.</p>                         |  |  |
| <p>The screen displays the values measured by the pressure sensors.</p>                                                 |                                                                                     |  |

**Note:** without air pressure, the number of "PRESSURE" points must be less than 100, for a nil flow, the number of "FLOW" points must be less than 200.

## 5. RESULTS MENU

This function is used for:

- ✓ the detailed display of the test results: number of parts tested, number of good parts, number of bad reference parts, number of bad parts, number of recovered parts, number of times the alarm is triggered (each indicator is expressed as a % value),
- ✓ resetting the results memory,
- ✓ printing the results (number of good parts, number of bad parts).

## 6. LANGUAGE MENU

This function allows the choosing of the instrument language. Several languages are available. Two are installed at the fabrication of the instrument, the English is the language by default the other is choose by the customer.

## 7. STAND BY MENU

This function is used to switch off the instrument without disconnecting it. Standby can be immediate or programmed with start and stop times.

There are two ways to achieve immediate standby:



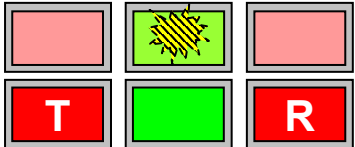
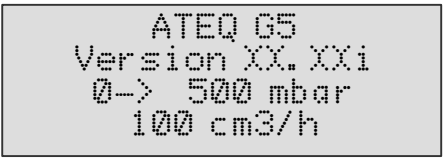











- 1) Either through the standby menu,
- 2) Or by pressing the **RESET**  button for more than three seconds.

|                                                                                                                                                      |  |                                                                                       |
|------------------------------------------------------------------------------------------------------------------------------------------------------|--|---------------------------------------------------------------------------------------|
| <p><b>Note:</b> when the instrument is on standby, the display is off and only the yellow indicator light flashes approximately every 3 seconds.</p> |  |  |
| <p>To reactivate the instrument, simply press any key on the front panel or activate any input.</p>                                                  |  |   |

 Select the option and enter settings if necessary.

7.1. STANDBY USING THE MENU

Standby using the menu enables start and stop times for the instrument to be programmed.

|                                                                                                                                                                                             |                                                                                                                                                                         |                                                                                                        |
|---------------------------------------------------------------------------------------------------------------------------------------------------------------------------------------------|-------------------------------------------------------------------------------------------------------------------------------------------------------------------------|--------------------------------------------------------------------------------------------------------|
| <p>In the main menu, position the cursor beside <b>STANDBY</b> and confirm by pressing <b>ENTER</b>.</p>                                                                                    |       | <pre> MAIN MENU RESULTS LANGUAGE : English STAND-BY                     </pre>                         |
| <p>To program automatic standby at a given time, position the cursor beside <b>STOP TIME</b>.</p>                                                                                           |       | <pre> STAND-BY Now           : No Pow-on time  : No STAND-BY     : No                     </pre>       |
| <p>Confirm the <b>STOP TIME</b> parameter using <b>YES</b></p>                                                                                                                              |       | <pre> STAND-BY Now           : No Pow-on time  : No Pow-off time : Yes                     </pre>      |
| <p>Then set parameters for the time (hours and minutes) when the standby must take effect. "<b>TIME DELAY</b>" is the delay (in minutes) between the programmed time and actual standby</p> |     | <pre> STAND/Pow-off time HOUR        : 00 MINUTE      : 00 Delay       : 00                     </pre> |
| <p>To program the start-up time for the instrument, position the cursor beside <b>START TIME</b></p>                                                                                        |   | <pre> STAND-BY Now           : No STAND-BY     : Yes Pow-off time : Yes                     </pre>     |
| <p>Confirm the <b>START TIME</b> parameter using <b>YES</b></p>                                                                                                                             |   | <pre> STAND-BY Now           : No STAND-BY     : Yes Pow-off time : Yes                     </pre>     |
| <p>Then set parameters for the instrument start time (in hours and minutes).</p>                                                                                                            |   | <pre> STAND/Pow-on time HOUR        : 00 MINUTE      : 00                     </pre>                   |

## Chapter 5

---

# ACCESSORIES

---

### 1. ACCESSORIES SUPPLIED WITH THE INSTRUMENT

#### 1.1. MAINS POWER CABLE (SUPPLIED WITH THE G570)

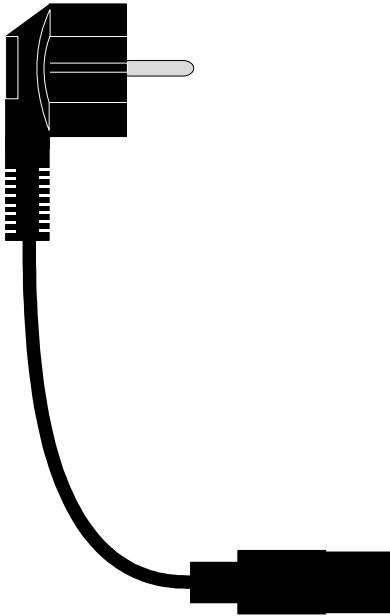

The power supply cable of the **G570** allows its connection to the mains supply network (from 90 to 260V AC).

## 2. OPTIONAL ACCESSORIES

### 2.1. CALIBRATED LEAK

Calibrated leaks are used to check the instrument's calibration.

| PRESSURE                    | Master leak type |     |      |      |      |     |      |      |      |      |      |
|-----------------------------|------------------|-----|------|------|------|-----|------|------|------|------|------|
|                             | A                | B   | 5    | C    | D    | 50  | E    | F    | G    | 1000 | 5000 |
| <b>2 kPa</b><br>(20 mbar)   |                  |     | 1,5  | 3,12 | 6,6  | 18  | 31,2 | 1,24 | 2,05 | 4,2  | 53   |
| <b>5 kPa</b><br>(50 mbar)   |                  | 2,3 | 4    | 7,4  | 17,5 | 42  | 1,3  | 2,6  | 5,25 | 11,3 | 132  |
| <b>15 kPa</b><br>(150 mbar) | 2,82             | 6,7 | 12   | 23   | 55   | 2,2 | 4    | 8,2  | 17   | 35,5 | 338  |
| <b>30 kPa</b><br>(300 mbar) | 4,8              | 12  | 24   | 46,8 | 2,12 | 3,6 | 7,6  | 22,4 | 40   | 74,5 | 700  |
| <b>50 kPa</b><br>(500 mbar) | 10               | 25  | 48   | 1,4  | 3,5  | 8   | 15,5 | 31   | 63   | 150  | 1142 |
| <b>100 kPa</b><br>(1 bar)   | 23               | 56  | 1,8  | 3,3  | 8    | 19  | 37   | 74   | 149  | 360  | 2230 |
| <b>200 kPa</b><br>(2 bar)   | 55               | 2,3 | 4,6  | 8,5  | 21   | 47  | 89   | 194  | 380  | 830  | 4343 |
| <b>400 kPa</b><br>(4 bar)   | 2,5              | 6,6 | 12,1 | 23,3 | 56   | 125 | 220  | 540  | 1030 | 1500 | 8750 |
| <b>1 MPa</b><br>(10 bar)    | 11,5             | 29  | 50   | 95   | 198  | 420 | 705  | 2310 | 3700 | 4450 |      |

 **kPa.cm<sup>3</sup>/h**  
(bar.cm<sup>3</sup>/h)

 **kPa.cm<sup>3</sup>/min**  
(bar.cm<sup>3</sup>/min)

**Note:** the values indicated above are given for information and can vary by +/- 20%. The true rate is precisely measured before delivery with an accuracy of +/- 5% up to 1Mpa.cm<sup>3</sup>/min (10 bar.cm<sup>3</sup>/min) and +/- 3% from this value. **Special master leaks can be manufactured on request, within 5% of the requested value.**

- ✓ The calibrated leaks must be used with clean dry air.
- ✓ These leaks must not be dipped in water. It is essential that they are stored in their case after usage.
- ✓ The leaks must be checked periodically by the company's metrology department or by **ATEQ's** metrology service.
- ✓ Check that there is an O-ring seal and that it is in good condition.
- ✓ The instrument zero check must be done by replacing the leak with a sealing connector and not by sealing off the leak itself.
- ✓ To check that the leak has not been blocked, attach a piece of flexible tubing to the leak and submerge its extremity in water to watch for bubbles. Only with pressure regulation and not vacuum.

## 2.2. NEEDLE VALVE AND LEAK/FLOW CALIBRATOR (CDF)

### 2.2.1. Needle valve

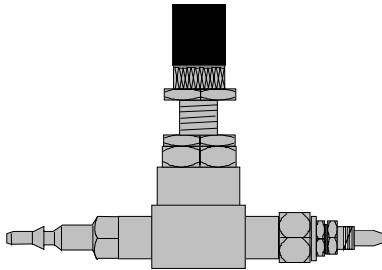

Needle valves are used to calibrate the leakage limits. These valves have an adjustable leak and depending on the model allow adjustments of between a few  $\text{cm}^3/\text{h}$  to several  $\text{l}/\text{min}$ .

These valves can be easily disturbed and therefore require the frequent use of some means of checking the setting (ex: **ATEQ** Leak/flow calibrator).

**Note:** it is strongly recommended that you do NOT leave a needle valve permanently connected on a leak detection machine with automatic calibration every « n cycles ».

### 2.2.2. CDF (Leak/flow Calibrator)

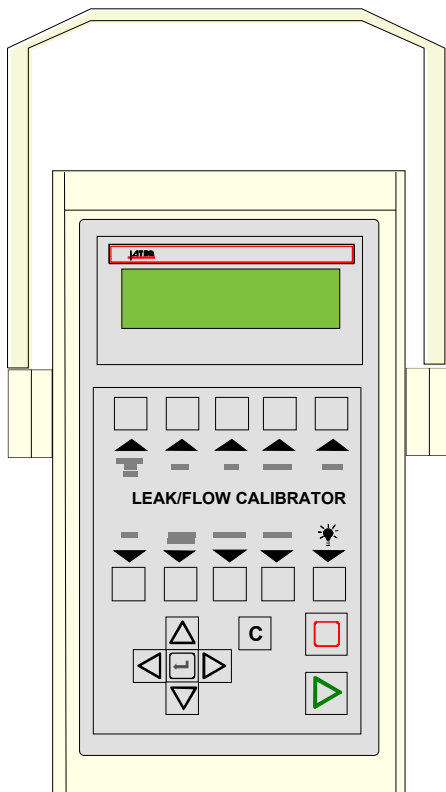

The **Leak/Flow calibrator** is a multiple range **ATEQ** flow meter intended for checking leak testing equipment and particularly **ATEQ** instruments. It measures a loss of charge with a differential sensor, which is connected to a calibrated flow tube.

### 2.3. AUTOMATIC CONNECTORS WITH EXPANDABLE JOINTS

**ATEQ** automatic connectors are used so that accurate and reliable assemblies can be built to check air tightness. They simplify the work of the operator as they are self-locking thanks to the use of a pneumatic valve supplied from the mains compressed air supply. Several connectors may be controlled by the same remote, powered by an **ATEQ** or another logic.

They adapt easily to a large number of fittings and apertures of varied dimensions. Their use ensures that non-machined walls can be guaranteed airtight.

There are four basic versions of **ATEQ** automatic connectors :

- ✓ SA for external connections,
- ✓ Si for internal connections,
- ✓ SAG and SIG for threaded and tapped connections.

They are either in anodised aluminium or stainless steel as standard. Different types of joints are available depending on the elasticity required.

#### 2.3.1. Operation

The connector is positioned manually or automatically using a jack or cylinder.

Compressed air is allowed through the control aperture via a three part valve. The pressure pushes the cylinder which squashes the connector. The air tightness is therefore perfect and there will be no leakage in the connector seals.

#### 2.3.2. Standard dimensions

SAG and SIG have been designed for threaded and tapped caps. For the time being, they are available in gas norm. Sizes, which are: 1/2", 3/4", 1", 1 1/4", 1 1/2", 2", BSP.

The SA and SI are designed for smooth nozzles, with dimensions from 3 to 80 mm for the external diameters (SA), and from 10 to 75 mm for the internal diameters (SI).

### 2.4. FILTRATION KIT

Clean, dry air must be used to ensure the reliability of the instruments.

The filtration kit is connected to the air input on the rear panel of the instrument.

It consists of a dust filtering cartridge (5µm) and another cartridge (0.01 µm) giving residual oil pollution equal to 0.01 ppm.

## 2.5. SIMPLE REMOTE CONTROL

The remote control allows control and selection of various settings remotely for instruments in the **ATEQ** range.

### 2.5.1. Casing reset/start

Example :  
START / RESET.

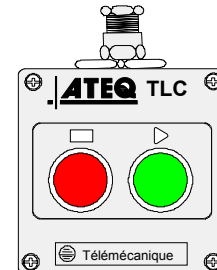

### 2.5.2. S5 four-function remote control

This remote control has four functions which can be used to control a series 5 instrument remotely. (F580 or C540 single head only).

The four functions on this remote control are as follows:

- ✓ RESET and start cycle.
- ✓ Increase or decrease program numbers.
- ✓ Display the number of the program selected.
- ✓ Display the test result, green indicator light for Pass, red indicator light for Fail or alarm.

**Note 1:** a program number can only be changed (increase or decrease) when no test cycle is running.

**Note 2:** this remote control does not function in the "Automatic start" mode.

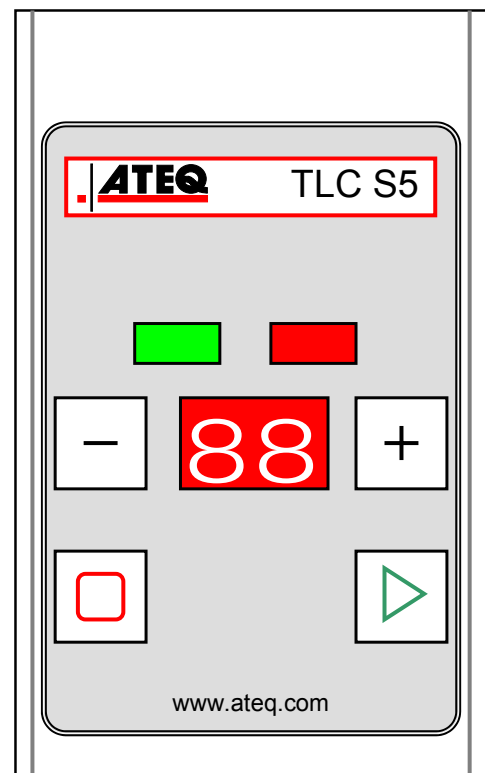

#### 2.5.2. 1) Connection diagram



## 2.6. EXTERNAL SHUT OFF VALVE OPTION

This option allows avoiding blowing air or gas permanently on the test output.

The "Automatic start" mode becomes incompatible.

There's the choice between an electrical or a pneumatic order according to the option presents in the instrument:

- Electrical piloting 24 V DC by the output code number 2 with the "shut off" option activated in the **CONFIGURATION** Menu.

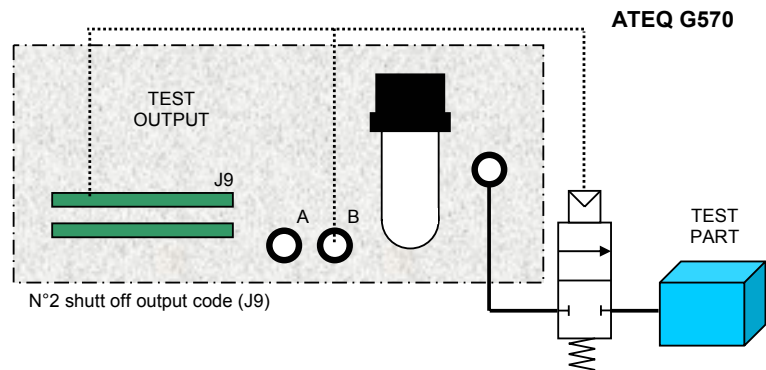

- Pneumatic piloting (6 bar network) with the A and B automatic connectors option. The shut off function must be activated in the **CONFIGURATION** menu.

## 2.7. EXTERNAL DUMP VALVE AND SHUT OFF FUNCTION

This assembly allows dumping the test part out of test cycle and not blowing permanently air or gas. The "External dump" option must be imperiously present in the instrument.

Use a 3/2 Y valve (ATEQ standard) who will be preferably close to the part to be tested.

The "Automatic start" mode is being incompatible.

The "External dump" function must be activated in the **CONFIGURATION** menu, choose the valve type, normally closed or normally opened and then activate the "External dump" function in the programs functions.

There's the choice between an electrical or a pneumatic order according to the option presents in the instrument:

- Electrical piloting 24 V DC by the output code number 2 with the "External dump" option activated in the **CONFIGURATION** Menu.

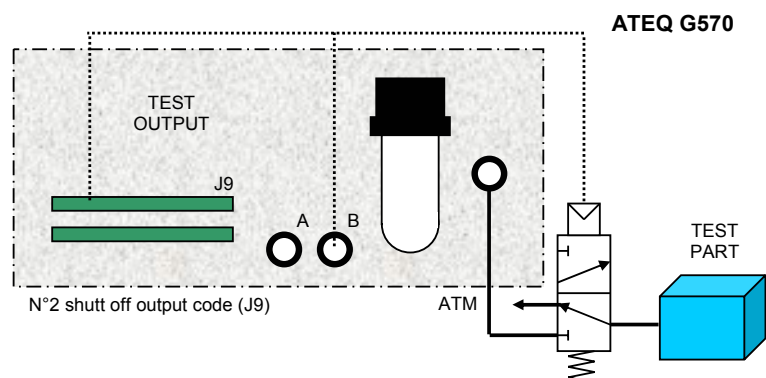



- Pneumatic piloting (6 bar network) with the A and B automatic connectors option. The "External dump" function must be activated in the **CONFIGURATION** menu.

## Chapter 6

# ERROR MESSAGES

The **ATEQ G570** can display error messages if there are operational problems.

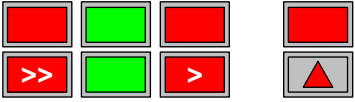
| PROBLEM                                                                                                                                                                                       | LIT INDICATORS | MESSAGE DISPLAYED                                                                                                                |
|-----------------------------------------------------------------------------------------------------------------------------------------------------------------------------------------------|----------------|----------------------------------------------------------------------------------------------------------------------------------|
| Test error. Flow in excess of the full scale.<br><b>Action:</b> check the test circuit.                                                                                                       |                | <pre>           CYCLE/Pr001           PRESS=0.942 bar           FLOW=&gt;&gt; F. S TEST           READY (NO OK)         </pre>   |
| Pressure in excess of the full scale. Negative flow.<br><b>Action:</b> check the test time, the part must not change in temperature. Refer to chapter 4 paragraph 2.12 "Negative flow alarm". |                | <pre>           CYCLE/Pr001           PRESS= 150.0 mbar           FLOW = &gt;&gt; F. S. REF.           READY (AL)         </pre> |
| Pressure in excess of the max. threshold of the pressure sensor.<br><b>Action:</b> reduce the pressure with the mechanical thumb wheel.                                                       |                | <pre>           CYCLE/Pr001           PRESS = &gt; F. SCALE           RESET WAIT         </pre>                                  |
| Default on the differential sensor.<br><b>Action:</b> contact the ATEQ After-sales service for a repair (probable presence of oil or water in the test circuit of the instrument).            |                | <pre>           CYCLE/Pr001           PRESS= 150.0 mbar           FLOW= SENSOR DEF.           READY (AL)         </pre>          |
| Pressure in excess of the max. threshold.<br><b>Action:</b> check regulator settings, and pressure limit .                                                                                    |                | <pre>           CYCLE/Pr001           PRESS= 140.0 mbar           PRESS= &gt; MAX           READY (AL)         </pre>            |
| Pressure below the min. threshold.<br><b>Action:</b> check the network pressure, regulator settings and the pressure limits.                                                                  |                | <pre>           CYCLE/Pr001           PRESS= 30.0 mbar           PRESS= &lt; MIN           READY (AL)         </pre>             |
| No Pressure<br><b>Action:</b> check the connection to air supply network and check the regulator adjustment.                                                                                  |                | <pre>           CYCLE/Pr001           PRESS= 0.0 mbar           PRESS= NIL PRESSURE           READY (AL)         </pre>          |

| PROBLEM                                                                                                                                                                                                   | LIT INDICATORS                                                                    | MESSAGE DISPLAYED                                                            |
|-----------------------------------------------------------------------------------------------------------------------------------------------------------------------------------------------------------|-----------------------------------------------------------------------------------|------------------------------------------------------------------------------|
| <p>PROG error: the I/O's have selected a program with no parameters.<br/> <b>Action:</b> enter program parameters.</p>                                                                                    |  | <pre>CYCLE/Pr.: 009 ERROR</pre>                                              |
| <p>Inappropriate size for the selected unit of pressure.<br/> <b>Action:</b> change unit or modify the minimum and maximum pressure limits if these and the test pressure can be used with this unit.</p> |  | <pre>PARAM/Pr001 &gt;Press. Unity: mbar MAX Fill : FPPP MIN Fill : 0.0</pre> |

## Chapter 7

---

# OPERATIONAL PROBLEMS

---

### 1. PHENOMENON NOTED

If a test machine begins to detect too many bad parts (statistically, more than three consecutively), it is advisable to carry out a **check on the whole unit**. The quality of the manufacture and operation of the leak detector should be the last things considered.

#### 1.1. CONDITION OF THE MACHINE'S SEALS

This is the no.1 defect as the seals are subject to high levels of dirt contamination (alumina, shavings). Regular cleaning of the seals is an effective remedy.

#### 1.2. DAMAGED INSTRUMENT SEALS

There is a possibility that the seals may be cut by shavings or worn by repetitive squashing. This can be prevented by regular servicing and replacement of the seals.

#### 1.3. BUMPER PAD

This is a defect which may occur after a certain amount of time as the bumper pads may be worn, or if the pressure settings in the air cylinder are inadvertently disturbed. Check the stability of the measurement and that the bumper pads are correctly installed.

#### 1.4. PNEUMATIC AIR SUPPLY TOO LOW

This anomaly can cause false measurements (large leaks or erratic measurements). The air supply to the cells must be higher than the minimum of 4 bar and it is essential that it is greater than the minimum test pressure of 1 bar. Also check that sealing connectors are being used correctly.

#### 1.5. PNEUMATIC LINK

The link and reference pipes will age and break with time. The pipes and seals must conform to the required quality. **ATEQ** recommends the use of RILSAN PA11 pipes and AVS type joints.

## 1.6. ENVIRONMENT

A measurement may be affected by a variation in background temperature (sun, draughts, storage of parts outdoors, handling of the test part by the operator, ...).

The dampness of parts may cause errors in the readings (insufficient drying after washing, outdoor storage, condensation, presence of water in the fixture, ...).

## 1.7. CALIBRATION

**ATEQ** does not accept any liability in regard to calibrations and settings to its instruments which are not carried out by its own staff.

## 1.8. CONCERNS ABOUT RELIABILITY OF THE INSTRUMENT'S CIRCUITS

If all the other checks do not resolve the problem, the instrument's circuit may be checked.

Proceed as follows:

- ✓ Segregate the instrument from its environment (pneumatic assembly),
- ✓ Connect up the instrument (test output),
- ✓ Choose an unused program,
- ✓ Set the parameters as follows :
  - ⇒ the regulator to the test pressure,
  - ⇒ the pressure monitoring thresholds to +/- 20 % of the test pressure,
  - ⇒ wait times A and B 0 seconds,
  - ⇒ fill time 2 seconds,
  - ⇒ stabilization time 2 seconds,
  - ⇒ test time 2 seconds,
  - ⇒ reject level 2,
  - ⇒ unit cm<sup>3</sup>/h,
  - ⇒ function all functions cancelled except "pressure correction".

Run two consecutive cycles.

The post test time result should not exceed 2 cm<sup>3</sup>/h.

## Appendices

---

# ATEQ G570

---

### 1. TECHNICAL CHARACTERISTICS OF THE G570

|                                                           | <b>G570</b>         |
|-----------------------------------------------------------|---------------------|
| <b>Dimensions</b><br>H x L x D (mm):                      | 160 x 540 x 305     |
| <b>Dimensions with air filter<br/>and regulator (mm):</b> | 160 x 540 x 395     |
| <b>Power supply:</b>                                      | 90 - 260 VAC / 50 W |
| <b>Pneumatic connections:</b>                             | 2,7/4, 3/5 or 4/6   |
| <b>Weight (kg):</b>                                       | about 15            |
| <b>Format:</b>                                            | 19 inches           |
| <b>Temperatures:</b>                                      |                     |
| Operational:                                              | +10°C to +45°C      |
| Storage:                                                  | 0°C to +60 °C       |

## 2. MECHANICAL DEFINITION DRAWINGS OF G570

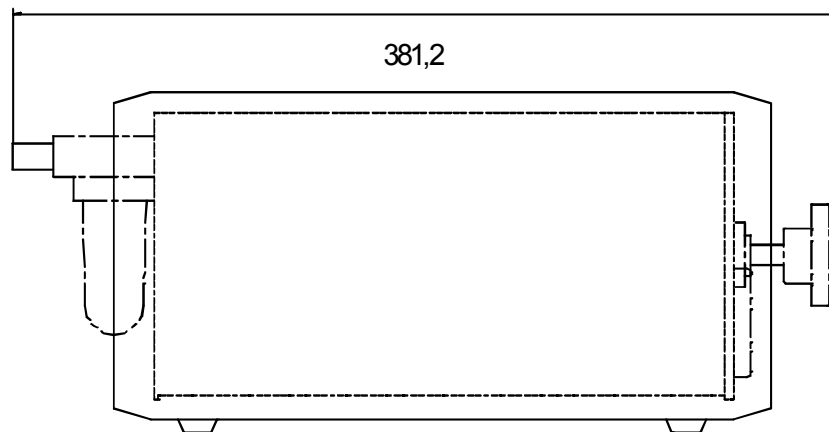
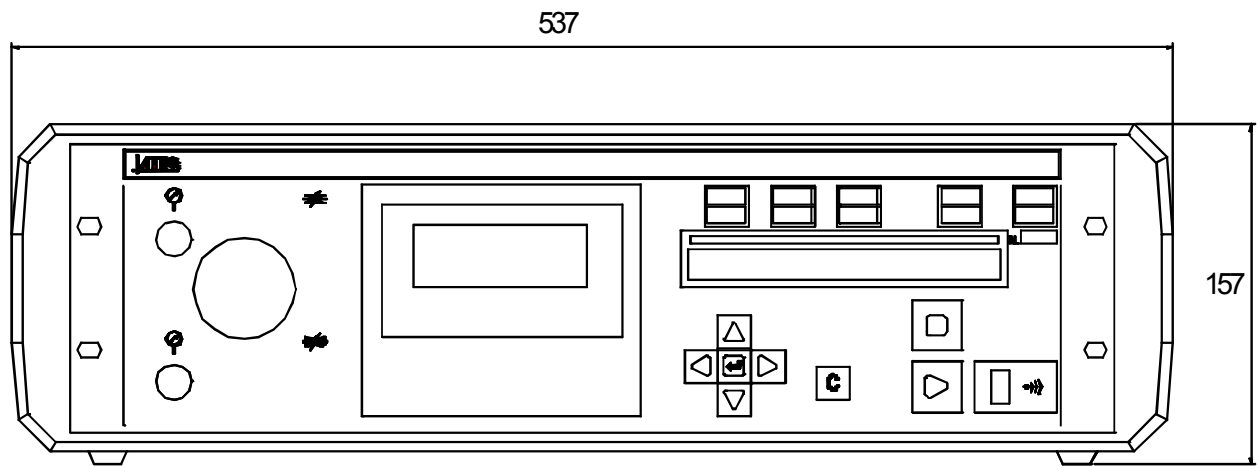

### 3. CONVERSION TABLE

|      |       | TO                    |                         |                         |                         |         |                         |                         |                         |                        |                        |
|------|-------|-----------------------|-------------------------|-------------------------|-------------------------|---------|-------------------------|-------------------------|-------------------------|------------------------|------------------------|
|      |       | Pa                    | kPa                     | bar                     | mbar                    | mmH2O   | atm                     | Torr                    | psi                     | inH2O                  | inHg                   |
| FROM | Pa    | 1                     | 10 <sup>-3</sup>        | 10 <sup>-5</sup>        | 10 <sup>-2</sup>        | 0.10197 | 9.8692 10 <sup>-6</sup> | 7.5 10 <sup>-3</sup>    | 1.45 10 <sup>-4</sup>   | 4.01 10 <sup>-3</sup>  | 2.95 10 <sup>-4</sup>  |
|      | kPa   | 10 <sup>3</sup>       | 1                       | 10 <sup>-2</sup>        | 10                      | 101.97  | 9.8692 10 <sup>-3</sup> | 7.5                     | 0.145                   | 4.01                   | 0.295                  |
|      | bar   | 10 <sup>5</sup>       | 10 <sup>2</sup>         | 1                       | 10 <sup>3</sup>         | 10197   | 0.98692                 | 750                     | 14.5                    | 401.46                 | 29.53                  |
|      | mbar  | 10 <sup>2</sup>       | 10 <sup>-1</sup>        | 10 <sup>-3</sup>        | 1                       | 10.197  | 9.8692 10 <sup>-4</sup> | 0.75                    | 1.45 10 <sup>-2</sup>   | 0.401                  | 2.95 10 <sup>-2</sup>  |
|      | mmH2O | 9.806                 | 9.8067 10 <sup>-3</sup> | 9.8067 10 <sup>-5</sup> | 9.8067 10 <sup>-2</sup> | 1       | 9.6784 10 <sup>-5</sup> | 7.3556 10 <sup>-2</sup> | 1.4223 10 <sup>3</sup>  | 3.937 10 <sup>-2</sup> | 2.895 10 <sup>-3</sup> |
|      | atm   | 1.013 10 <sup>5</sup> | 101.33                  | 1.0133                  | 1013.3                  | 10332   | 1                       | 760                     | 14.695                  | 406.78                 | 29.921                 |
|      | Torr  | 133.32                | 0.13332                 | 1.3332 10 <sup>-3</sup> | 1.3332                  | 13.595  | 1.3158 10 <sup>-3</sup> | 1                       | 1.9337 10 <sup>-2</sup> | 0.535                  | 3.937 10 <sup>-2</sup> |
|      | psi   | 6897.8                | 6.8948                  | 6.8948 10 <sup>-2</sup> | 68.948                  | 703.07  | 6.8045 10 <sup>-2</sup> | 51.71                   | 1                       | 27.68                  | 2.036                  |
|      | inH2O | 249.09                | 0.2491                  | 2.4909 10 <sup>-3</sup> | 2.4909                  | 25.400  | 2.4583 10 <sup>-3</sup> | 1.8683                  | 3.61 10 <sup>-2</sup>   | 1                      | 7.35 10 <sup>-2</sup>  |
|      | inHg  | 3386.4                | 3.3864                  | 3.3864 10 <sup>-2</sup> | 33.864                  | 345.32  | 3.3421 10 <sup>-2</sup> | 25.4                    | 0.491                   | 13.595                 | 1                      |

#### 4. PARAMETERS STORED

| PARAMETERS                                               |                                     | Program n°        | Program n° | Program n° | Program n° |
|----------------------------------------------------------|-------------------------------------|-------------------|------------|------------|------------|
| <b>T<br/>I<br/>M<br/>E</b>                               | Waiting                             |                   |            |            |            |
|                                                          | Rise                                |                   |            |            |            |
|                                                          | Stabilization                       |                   |            |            |            |
|                                                          | Drop                                |                   |            |            |            |
| <b>R<br/>E<br/>J<br/>E<br/>C<br/>T<br/>S</b>             | Test reject                         |                   |            |            |            |
|                                                          | Reference reject                    |                   |            |            |            |
|                                                          | Recovery test reject                |                   |            |            |            |
|                                                          | Recovery reference reject           |                   |            |            |            |
|                                                          | Rejection unit                      |                   |            |            |            |
|                                                          | Start pressure                      |                   |            |            |            |
|                                                          | Stabilization pressure              |                   |            |            |            |
|                                                          | End pressure                        |                   |            |            |            |
| <b>P<br/>R<br/>E<br/>S<br/>S<br/>U<br/>R<br/>E<br/>S</b> | Maximum Stabilization pressure      |                   |            |            |            |
|                                                          | Minimum threshold pressure          |                   |            |            |            |
|                                                          | Minimum rise flow pressure          |                   |            |            |            |
|                                                          | Maximum drop flow pressure          |                   |            |            |            |
|                                                          | Minimum Stabilization flow pressure |                   |            |            |            |
|                                                          | Maximum Stabilization flow pressure |                   |            |            |            |
|                                                          | Minimum drop flow pressure          |                   |            |            |            |
|                                                          | Maximum drop flow pressure          |                   |            |            |            |
|                                                          | Pressure unit                       |                   |            |            |            |
|                                                          | <b>F<br/>L<br/>O<br/>W<br/>S</b>    | Minimum rise flow |            |            |            |
| Rise flow                                                |                                     |                   |            |            |            |
| Stabilization flow                                       |                                     |                   |            |            |            |
| Maximum drop flow                                        |                                     |                   |            |            |            |

**5. VALVES CODES USED IN YOUR APPLICATION**

PROGRAM GROUP:

| <b>PROGRAM</b> | <b>VALVE CODE</b> | <b>FUNCTION</b> |
|----------------|-------------------|-----------------|
| <b>01</b>      |                   |                 |
| <b>02</b>      |                   |                 |
| <b>03</b>      |                   |                 |
| <b>04</b>      |                   |                 |
| <b>05</b>      |                   |                 |
| <b>06</b>      |                   |                 |
| <b>07</b>      |                   |                 |
| <b>08</b>      |                   |                 |
| <b>09</b>      |                   |                 |
| <b>10</b>      |                   |                 |
| <b>11</b>      |                   |                 |
| <b>12</b>      |                   |                 |
| <b>13</b>      |                   |                 |
| <b>14</b>      |                   |                 |
| <b>15</b>      |                   |                 |
| <b>16</b>      |                   |                 |



## Index

|                                         |        |
|-----------------------------------------|--------|
| <b>A</b>                                |        |
| Access position key .....               | 23     |
| Additional functions .....              | 41     |
| Automatic connectors .....              | 45, 76 |
| Automatic save .....                    | 54     |
| Automatic start.....                    | 44     |
| Auto-zero frequency .....               | 54     |
| <b>B</b>                                |        |
| Bar graph.....                          | 55     |
| <b>C</b>                                |        |
| C540 / F580.....                        | 55     |
| Calibration leaks .....                 | 74     |
| Clock .....                             | 55     |
| Conversion table.....                   | 85     |
| Create a new program.....               | 25     |
| Cycle end.....                          | 47     |
| Cycle keys .....                        | 22     |
| Cycle several test cycles .....         | 45     |
| <b>D</b>                                |        |
| Deactivating the start key .....        | 60     |
| Delete a program.....                   | 33     |
| Determine the fill time.....            | 28     |
| Determine the stabilization time.....   | 29     |
| Dimensions.....                         | 84     |
| Duplicate a program .....               | 32     |
| <b>E</b>                                |        |
| Electrical connectors .....             | 12     |
| Electrical connectors G570.....         | 12     |
| Error indicator .....                   | 24     |
| Export results to MS Excel.....         | 58     |
| Extended menus.....                     | 41     |
| External dump .....                     | 61, 78 |
| <b>F</b>                                |        |
| Fill instruction.....                   | 30     |
| Filtration kit .....                    | 76     |
| Flow mode.....                          | 26     |
| Functions menu .....                    | 31, 39 |
| <b>I</b>                                |        |
| I/O Configuration .....                 | 63     |
| Infinite fill.....                      | 66     |
| Infra-red link.....                     | 24     |
| <b>L</b>                                |        |
| Language.....                           | 71     |
| Large leak indicator .....              | 24     |
| LCD 4 line display.....                 | 23     |
| Leak/Flow calibrator .....              | 75     |
| Lighting the screen .....               | 60     |
| Locked position key .....               | 23     |
| <b>M</b>                                |        |
| Maximum fill.....                       | 30     |
| Measurements characteristics.....       | 6      |
| Minimum fill.....                       | 30     |
| Modbus .....                            | 59, 60 |
| <b>N</b>                                |        |
| Navigation keys .....                   | 22     |
| Needle valves .....                     | 75     |
| Negative flow .....                     | 63     |
| <b>O</b>                                |        |
| Operational characteristics .....       | 7      |
| Operational problems .....              | 81     |
| Operator mode.....                      | 26     |
| <b>P</b>                                |        |
| Parameter settings.....                 | 27     |
| Part BAD indicator .....                | 24     |
| Part OK indicator .....                 | 24     |
| Part volume calculation.....            | 65     |
| Pneumatic connectors .....              | 19     |
| Pneumatic supply .....                  | 20     |
| Pression (zero).....                    | 79     |
| Pressure correction.....                | 42     |
| Pressure inferior to min threshold..... | 79     |
| Pressure over max threshold.....        | 79     |
| Pressure too high.....                  | 79     |
| Pressure units.....                     | 29     |
| Print .....                             | 68     |
| Print frame .....                       | 56     |
| Print frame formats .....               | 56     |
| Print parameters .....                  | 55     |
| Print the results.....                  | 55     |
| Printer .....                           | 13, 55 |
| Printing the results.....               | 71     |
| Program choice.....                     | 34     |
| Program name .....                      | 42     |
| Programmable input .....                | 17     |
| <b>Q</b>                                |        |
| Quick connectors .....                  | 23     |
| <b>R</b>                                |        |
| Recoverable reject level .....          | 43     |
| Recoverable thresholds .....            | 43     |
| Reject unit.....                        | 30     |
| Remote control .....                    | 14, 77 |
| Remote control (S5).....                | 77     |
| Reset (automatic) .....                 | 67     |
| Results memory reset.....               | 71     |
| RS 485.....                             | 14     |
| RS232.....                              | 13     |
| RS485.....                              | 60     |
| <b>S</b>                                |        |
| Security.....                           | 60     |
| Sending conditions .....                | 57     |
| Sensor default.....                     | 79     |
| Sensor servicing .....                  | 70     |

|                                 |    |                                       |    |
|---------------------------------|----|---------------------------------------|----|
| Service menu.....               | 69 | Test error .....                      | 79 |
| Service parameters .....        | 82 | Test output.....                      | 19 |
| Set pressure .....              | 30 | Test reject.....                      | 31 |
| Shut off .....                  | 62 | Test results display (detailed) ..... | 71 |
| Shut off valve.....             | 78 | Test time .....                       | 29 |
| Smoothing .....                 | 42 | Type of pre-fill .....                | 53 |
| Stabilization time .....        | 29 | <b>V</b>                              |    |
| Stamping .....                  | 46 | Valve codes .....                     | 43 |
| Stand by .....                  | 71 | Volume .....                          | 31 |
| Standard conditions .....       | 42 | Volume calculation.....               | 53 |
| Stop the measurement .....      | 34 | <b>W</b>                              |    |
| Symbols.....                    | 8  | Wait times A and B .....              | 28 |
| <b>T</b>                        |    |                                       |    |
| Technical characteristics ..... | 83 |                                       |    |



