

ATEQ F670
Version 1.0



(Photo no contractual)

www.ateq.com

REVISIONS OF THE ATEQ F670 USER MANUAL

Due to continuing improvements, the information contained in this user manual, the features and design of this device are subject to be changed without prior notice.

<u>Edition/Revision</u>	<u>Reference</u>	<u>Date</u> Week/Year	<u>Chapters up dating</u>
First edition	MR-36300A-U	15/2013	-----
Second edition	MR-36300C-U	20/2013	Minor corrections. C Indice to be the same as the F620 (B indice cancelled).

Quick start manual

TABLE OF CONTENTS

TABLE OF CONTENTS	1
PREAMBULE	2
1. DEFINITION OF THE ATEQ F670	2
2. MEASUREMENT CHARACTERISTICS	2
3. THE MAIN TYPES OF MEASUREMENT	3
4. THE THREE TYPES OF TEST	3
5. MEASUREMENT CYCLE	3
INSTALLATION	4
1. APPEARANCE OF THE ATEQ F670	4
2. ELECTRICS CONNECTORS	5
3. PNEUMATIC SUPPLY	10
4. PNEUMATIC CONNECTORS	11
USER INTERFACES	12
1. CYCLE KEYS	12
2. TOUCHES DE NAVIGATION	12
STARTING UP AND ADJUSTMENTS	14
1. TEST MENU	14
2. MAIN MENU	14
3. PROGRAMS MANAGEMENT	15
4. PARAMETERS	16
5. START AND STOP MEASUREMENT CYCLE	17
6. FUNCTIONS	18
OTHERS MENUS	19
1. SPECIAL CYCLES	19
2. MENU CONFIGURATION	20
3. SERVICE MENU MAINTENANCE	21
4. RESULTS MENU	21
5. USB MENU	21
ACCESSORIES AND CHARACTERISTICS	22
1. ACCESSORIES PROVIDED	22
2. ACCESSORIES IN OPTION	22
3. TECHNICAL CHARACTERISTIC OF THE F670	23
ERRORS AND FAULTS	24
1. ERROR MESSAGES	24
2. IN CASE OF OPERATION DOUBT	24
INDEX	25

Due to continuing improvements, the information contained in this user manual, the features and design of this device are subject to be changed without prior notice.

PREAMBULE

1. DEFINITION OF THE ATEQ F670

The **ATEQ F670** is a compact air/air leak detector used to test the airtightness of parts. The method used is based on the measurement of a small variation or drop in differential pressure between the test and reference parts, when both are filled to an identical pressure.

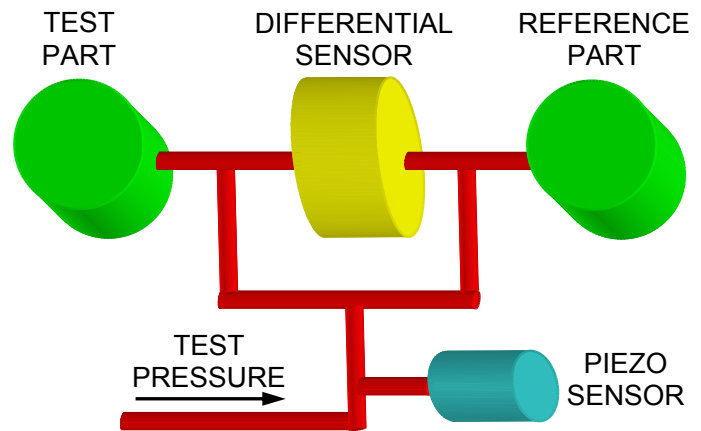

2. MEASUREMENT CHARACTERISTICS

2.1. PRESSURE DROP MEASUREMENT

RANGE	ACCURACY	RESOLUTION Maximum
0 – 500 Pa	+/- (2,5% of the pressure + 1 Pa)	0,1 Pa

2.2. TEST PRESSURE MEASUREMENT

RANGE	ACCURACY	RESOLUTION Maximum
F.S. = 200 mbar	+/- (1,5% of the pressure+ 0,2 hPa)	0,1 % F.S.
0.2 < F.S. ≤ 5 bar	+/- (1,5% of the pressure + 7.5 hPa)	0,1 % F.S.
5 < F.S. ≤ 10 bar	+/- (1,5% of the pressure + 15 hPa)	0,1 % F.S.

F.S. = Full scale.

3. THE MAIN TYPES OF MEASUREMENT

Direct measurement, indirect measurement and sealed component measurement. These three methods apply to measurements taken both under pressure and in vacuum conditions.

The configuration is determined by the application and must be carried out prior to the use of the instrument.

4. THE THREE TYPES OF TEST

Test with reference: measurement of a pressure variation between a test part and a reference part.

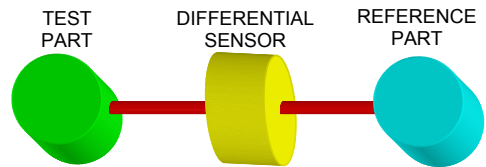

Test without reference: measurement of a variation in pressure between a test part and a sealing connector on the reference side.

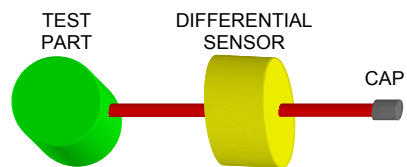

Test with central zero: test of two parts at the same time. One part is connected to the test side and the other to the reference side.

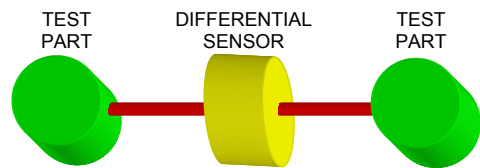

5. MEASUREMENT CYCLE

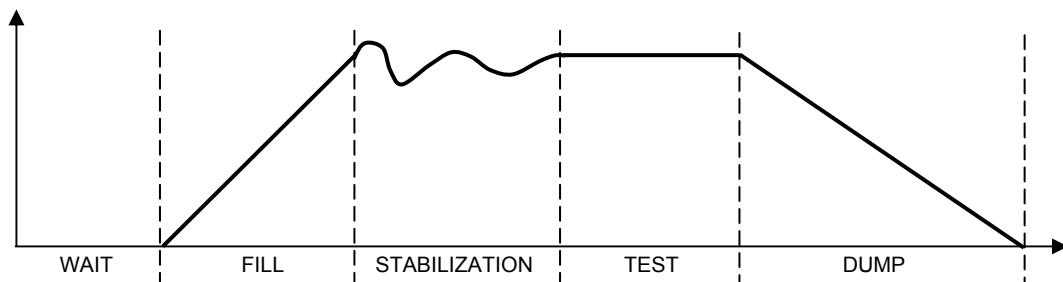

The measurement cycle consists of 5 phases:

	1	2	3	4	5	
Start	Coupling time	Fill time	Stabilization time	Test time	Dump time	Cycle end

INSTALLATION

1. APPEARANCE OF THE ATEQ F670

1.1. FRONT FACE



1.2. REAR SIDE



2. ELECTRICS CONNECTORS

2.1. POWER SUPPLY WITH 100 / 240 V AC AND ON/OFF SWITCH (OPTION)



Supply the **ATEQ F670** with the built in power supply, with a voltage between 100 and 240 V AC - 50 W.

I: ON / O: OFF.

2.2. USB CONNECTOR (FRONT FACE)

Allows the connection of miscellaneous compatibles **USB** devices. The connectors are located under the rubber cover.

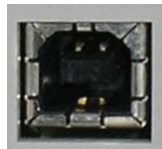

USB connector to plug a PC.



USB connector to plug an UBS memory key or a remote control.

The USB connector rubber cover can be slightly deviated to the front for easy access to connectors.



2.3. J1 RS232 CONNECTOR PRINTER

2.3.1. Connector in RS232 mode

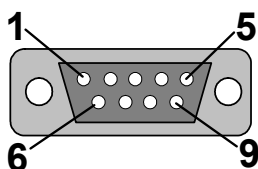

RS232: SubD 9 points male connector. To plug a printer or a PC.



Pin 1	Not used	Pin 4	Not used	Pin 7	RTS request to send
Pin 2	RXD data input	Pin 5	Earth/Ground	Pin 8	CTS clear to send
Pin 3	TXD data output	Pin 6	Not used	Pin 9	Not used

2.3.1. 1) Examples of RS232 cables

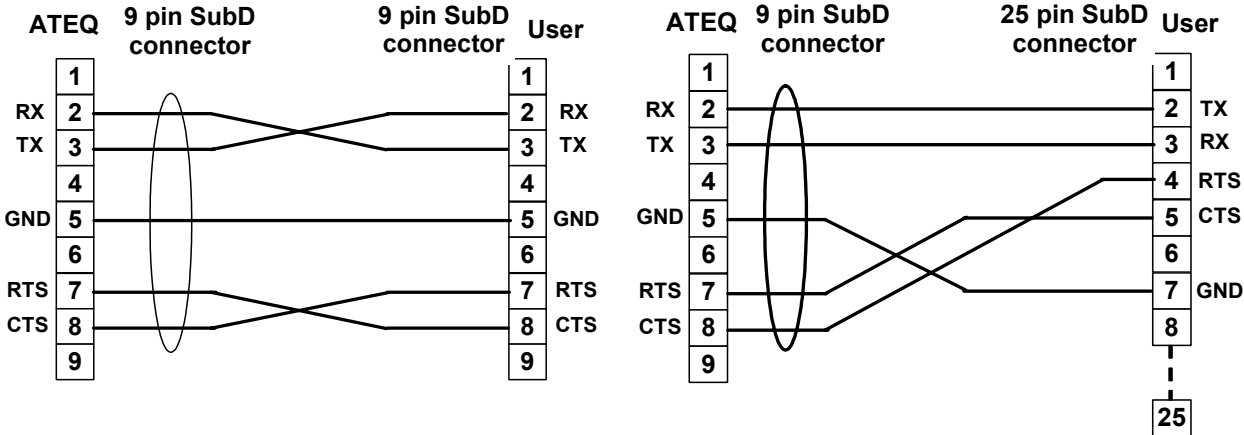

2.4. J2 CONNECTOR PROFIBUS / MODBUS

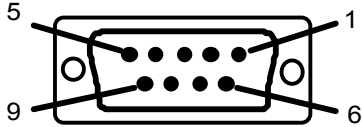

Profibus: SubD 9 points female connector.



2.5. J3 CONECTOR ANALOG OUTPUTS (OPTION)

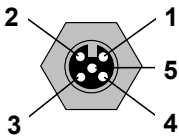

Connection for analog outputs.

- Pin 1: sensor 1 (plus).
- Pin 2: sensor 1 (minus).
- Pin 3: sensor 2 (plus).
- Pin 4: sensor 2 (minus).

2.6. J6 CONNECTOR (OPTION)

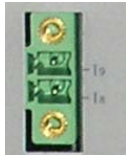

The J6 connector is an extension (option) to be able to select 128 programs.

Pin	Standard Mode	Compact Mode	
1	Input 8 Program selection	Input 8 Program selection 33 to 64.	Inputs (Activation by 24 V DC) Common + 24 V = 0,3 A maximum
2	Input 9 Program selection	Input 9 Program selection 65 to 128	

2.7. J7 CONNECTOR I/O ALL OR NOTHING

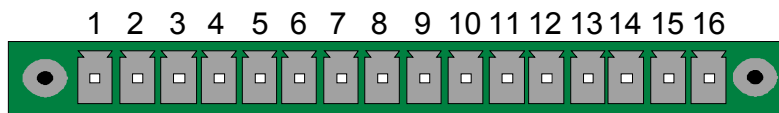

Inputs / Outputs All or Nothing.

Pin	Standard Mode	Compact Mode	
1	Input 1 RAZ	Input 1 RAZ	Inputs (Activation by 24 V DC) Common + 24 V = 0,3 A maximum
2	Common (+ 24 V)	Common (+ 24 V)	
3	Input 2 START	Input 2 START	
4	Common (+ 24 V)	Common (+ 24 V)	
5	Input 3 Program selection	Input 3 Program selection	
6	Input 4 Program selection	Input 4 Program selection	
7	Input 5 Program selection	Input 5 Program selection	
8	Input 6 Program selection	Input 6 Program selection	
9	Input 7 Program selection	Input 7 Program selection	
10	Floating common output	Floating common output	Outputs dry contacts 60V AC / DC Max 200mA Max
11	Output 1 Pass part	Output 1 Pass part cycle 1	
12	Output 2 Fail Test part	Output 2 Fail part cycle 1 + Alarm	
13	Output 3 Fail reference part	Output 3 Pass part cycle 2	
14	Output 4 Alarm	Output 4 Fail part cycle 2 + Alarm	
15	Output 5 End of cycle	Output 5 End of cycle	
16	0 V	0 V	

The compact mode is a software function which is activated in the **CONFIGURATION/ AUTOMATISM / CHANGE I/O / OUTPUT** menu.

Combinations of pins to activate to select programs

Program number	J7 Pin 5 (input 3)	J7 Pin 6 (input 4)	J7 Pin 7 (input 5)	J7 Pin 8 (input 6)	J7 Pin 9 (input 7)	J6 Pin 1 (input 8)	J6 Pin 2 (input 9)
1	0	0	0	0	0	0	0
2	1	0	0	0	0	0	0
3	0	1	0	0	0	0	0
4	1	1	0	0	0	0	0
5	0	0	1	0	0	0	0
6	1	0	1	0	0	0	0
7	0	1	1	0	0	0	0
8	1	1	1	0	0	0	0
9	0	0	0	1	0	0	0
10	1	0	0	1	0	0	0
11	0	1	0	1	0	0	0
12	1	1	0	1	0	0	0
13	0	0	1	1	0	0	0
14	1	0	1	1	0	0	0
15	0	1	1	1	0	0	0
16	1	1	1	1	0	0	0
17 à 32	x	x	x	x	1	0	0
33 à 64	x	x	x	x	x	1	0
65 à 128	x	x	x	x	x	x	1

With **x** who takes the 0 or 1 value in function of the program number to be called.

2.8. J8 / J10 CONNECTORS INPUTS (OPTION)

Location for little Inputs boards in option.

2.9. J9 CONNECTOR I/O ALL OR NOTHING (OPTION)

Location for an additional relay board in option.

2.10. J11 CONNECTOR OUTPUT CODES / ANALOG

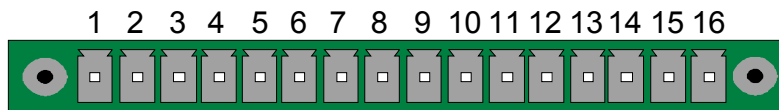

Output codes / analogue outputs / temperature sensor.

Pin 1	COMMUN (Outputs 1, 2, 3) + 24 V DC	Output codes 24V DC 100mA Max	
Pin 2	Output n°1, open collector		
Pin 3	Output n°2, open collector		
Pin 4	Output n°3, open collector		
Pin 5	COMMON (Outputs 4, 5, 6) + 24 V DC		
Pin 6	Output n°4, open collector		
Pin 7	Output n°5, open collector	Inputs	
Pin 8	Output n°6, open collector		
Pin 9	Input 0 (NPN or PNP)*		
Pin 10	Input 1 (NPN or PNP)*		
Pin 11	Input 2 (NPN or PNP)*		
Pin 12	Input 3 (NPN or PNP)*	Analogue outputs	
Pin 13	Input 4 (NPN or PNP)*		
Pin 14	Ground		
Pin 15	Input 5 (NPN or PNP)*		
Pin 16	Ground		

* Inputs NPN or PNP following the strap position on the board.

3. PNEUMATIC SUPPLY



Air supply is via the filter located on the rear panel of the Air supply is via the filter located on the rear panel of the instrument.

The air must be clean and dry.

The supply pressure must always be between 4 and 8 bar (400 kPa and 800 kPa).

4. PNEUMATIC CONNECTORS

The pneumatics connectors are located on the rear side.

4.1. AUTOMATIC CONNECTOR A AND B (OPTION)



To drive pneumatics caps.

4.2. PNEUMATICS TEST OUTPUTS

These outputs enable parts to be connected (test, reference). The pressurization output is used for the addition of **ATEQ** accessories (Y valve).

Inputs / Outputs on the rear side of the **F670**:

Reference Output R

Pressurization Output

Test Output T



4.3. QUICK CONNECTORS (OPTION)



One quick connector may be mounted on the front panel of the instrument.

This connector is to check the calibration. It's used to check the test circuit and enables, by use of a calibrated leak, calculation of the equivalent pressure drop.

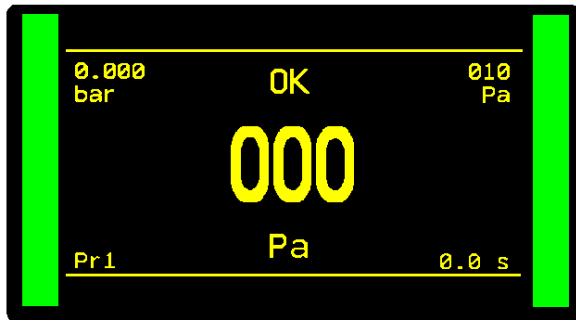

⚠ As this connector is part of the measurement circuit, all its connections must be air tight.

USER INTERFACES







Used to display measurements and adjustable parameters.

1. CYCLE KEYS

KEY	FUNCTION	KEY	FUNCTION
	START key Start a measurement cycle.		RESET Key Current measurement cycle stop.

2. TOUCHES DE NAVIGATION

2.1. TOUCHES DE NAVIGATION

TOUCHE	FONCTION
	Scroll up or increase numerical values.
	Scroll down or decrease numerical values
	Opening a menu, entering a parameter, confirmation of a parameter.
	Return to the previous menu or function, escape without modifying a parameter
	Programmable key by the user's preferences (see below).

2.2. "SMART KEY" KEY FUNCTIONS

The "**Smart Key**" key can be programmed following the user preferences; this can have a direct access to the selected function.

The programming for this key is done from the **CONFIGURATION / MISCELLANEOUS / SMART KEY** menu.

The functions to assign are:

- **Special cycle menu:** to access to the menu of special cycle selection.
- **Special cycle:** to run the special cycle selected in the list of the available ones.
- **Parameters:** to access directly to the program parameters menu.
- **Program defined:** to access directly to the selected program parameters.
- **Run program:** to access directly to the current program parameterst (run program).
- **Last results :** to access directly to the test results menu.

STARTING UP AND ADJUSTMENTS

1. TEST MENU

The test menu (or window) is displayed during a cycle measurement.

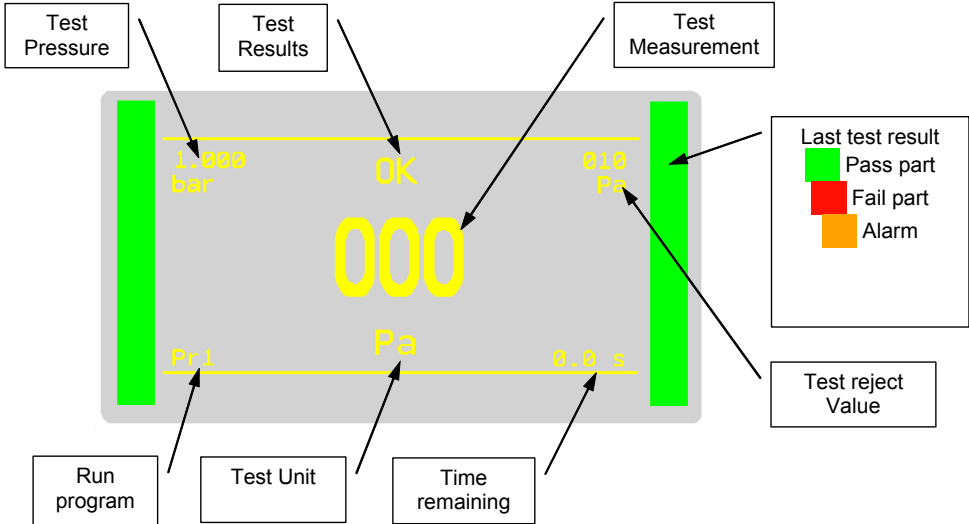

By pressing the "OK" key or "Esc" key gives access to the menu.

2. MAIN MENU

The main menu allows accessing to the different menus for the management of the device.

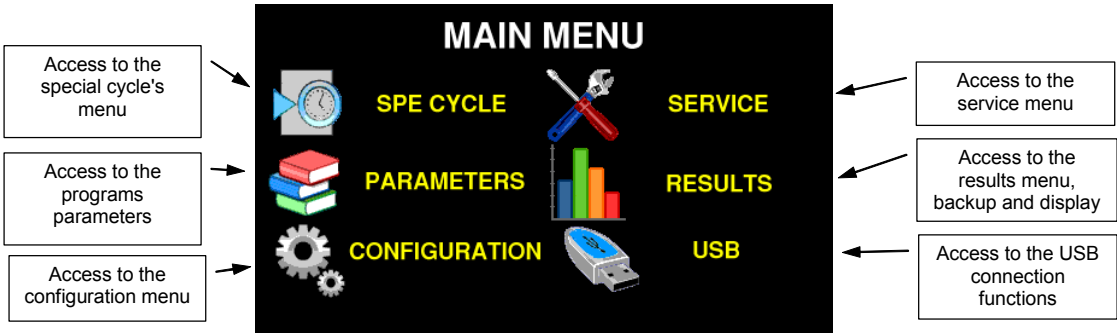

3. PROGRAMS MANAGEMENT

3.1. LEAK PROGRAM CREATION

From the main menu, select the "**PARAMETERS**" menu by using the "**Up**" and "**Down**" keys and then validate with "**OK**".



Select the test program number to create (or modify).

----- for an empty program.

Then Select the test type: **LEAK**.

The parameters menu is displayed, access to each parameter by using the "**Up**" or "**Down**" keys and validate with "**OK**" to edit the parameter.

Then by using the "**Up**" or "**Down**" keys and adjust the parameter to the desired value and validate with "**OK**".

Do the same process for all the others parameters.

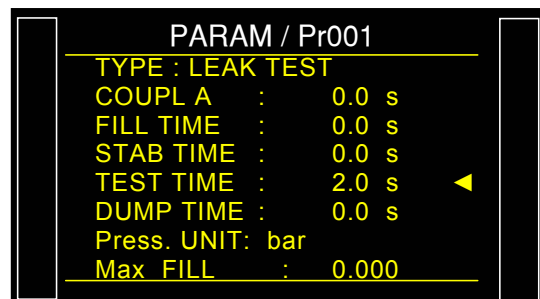
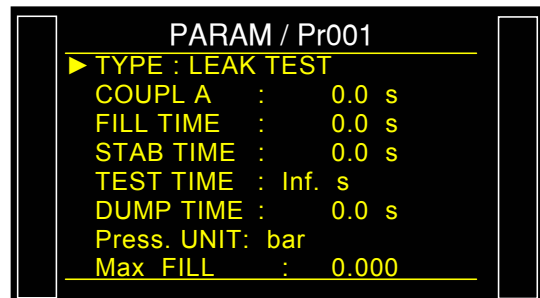
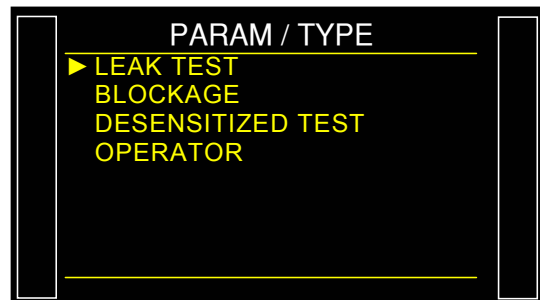
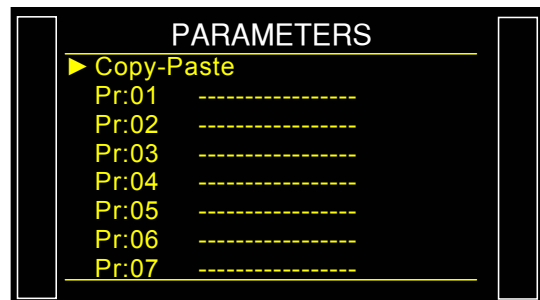

4. PARAMETERS

Main parameters to configure:

Fill time:	Time to fill the part to the test pressure.
Stabilization time:	Time to equalize the pressure between the TEST and REFERENCE components.
Test time:	Leak measurement time, it depends of the reject level value and the work mode programmed.
Dump time:	Time to back the part to the atmospheric pressure. Dump time by default is zero.
Pressure unit:	Pressure unit (bar, mbar, PSI, Pa, kPa, MPa).
Maximum fill:	Maximum level of the fill pressure.
Minimum fill:	Minimum level of the fill pressure.
Fill instruction:	Test pressure that the device will automatically regulate. <i>Remind: the input pressure must be at least greater than 100 kPa (1 bar) of the test pressure.</i>
Reject unit :	Leak unit displayed. If a flow unit is selected, two parameters are added.
Test reject:	Level for the test part is fail.
Reference reject:	Level for the reference part is fail (possible problem on this part). <i>Note: when the reference reject value is 0, the device takes into account the absolute value of the symmetrical test reject.</i>
Functions :	Menu to access to the extended functions that must be activated in the " More functions " menu. <i>Note: if no extended function has been activated from the "More Functions" menus, the FUNCTION menu is empty.</i>

Edition, duplication, deletion or copy of a test program, program number to start:
see the manuals CDROM for further information.

5. START AND STOP MEASUREMENT CYCLE

5.1. RUN PROGRAM SELECTION

From the "Cycle" menu, press on the "Up" or "Down" keys, the run program number is displayed.



5.2. RUN A CYCLE

Press the **START** key to run the measurement cycle.



Press the **RESET** key to stop the current measurement cycle. The message "OK" show the device is pending a new test cycle.



At the end of the measurement cycle, the test result is displayed.

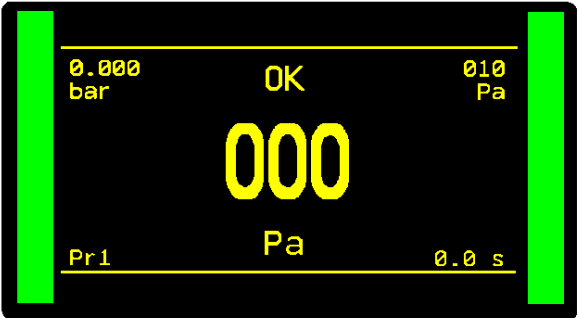

6. FUNCTIONS

6.1. PROGRAMS FUNCTIONS

The functions program allows improving the test measurement or suit the program or the device to its environment.

These functions are:

- Name
- Program sequence
- Units
- Filter
- Automatic Connector
- Calibration check by volume
- Transient Attenuation (ATR 0, 1 , 2 or 3)
- Pre Fill Type
- Fill Type
- Valves Codes
- Auxiliaries Outputs 24 V DC
- End Of Cycle
- Mini-Valve -----
- Rework Limit
- Sealed Components
- N tests
- Peak Hold
- Reference Volume
- Volume Compute
- Temperature 1 Correction
- Sign
- Flow Level
- No Negative
- Absolute
- Display Mode
- Buzzer

These functions, to appear in the program, must be activated first in the "**More functions**" menu.

Then it must validate and configure it in function menu of the program.

Each program can be individually personalized.

OTHERS MENUS

1. SPECIAL CYCLES

To start a special cycle, select it in the "**Special cycles**" menu, then press the  key.

To stop it, press the  key or for some cycles the end is automatic.

1.1. STANDARD SPECIAL CYCLES

Following the extended menu validations or following the device options, some des special cycles can appear:

None: no special cycle selected.

Infinite fill: to pressurize the part with a infinite fill time.

Piezo auto zero: to run an auto zero cycle on the piezo sensor and on the electronic pressure regulator.

Sealed component learning pass and fail part: this is pressure parameters learning cycles for the sealed component mode. The pass part learning cycle is obligatory.

Calibration check: cycle to check the calibration by volume with a pass part.

Learning / Check: these cycles allow running a learn or a check cycle (or both) in Pascal or Pascal/sec calibrate mode with a master leak.

ATR Learning: cycle to enter ATR parameters; this is to run at each switching on of the device or after a long time without measurement.

Volume calculation: cycle to calculate the volume of the test circuit.

2. MENU CONFIGURATION

This is to suit the device to the user's preferences.

Language: to select the language displayed on the screen.

Pneumatic: to configure the pneumatics functions of the device, the following parameters are available:

- Regulator control
- Permanent regulator
- Piezzo automatic AZ, auto-zero carried on automatically with a defined frequency.
- Short Auto zero, to carry on an only pressure sensor auto-zero.
- Pressure Unit, pressure unit by default for the new programs.
- Blow mode, activation of the blowing between two test cycles.
- Dump level, warning concerning the part stayed under pressure at the end of cycle.

Automatism: to configure the different communications between the device and its environment:

- RS232, to configure the communication type and the RS232 port.
- Date & Time, to set the built in clock.
- Change I/O, to configure the programmable inputs or outputs. See the installation paragraph.

Security: security functions:

- Start OFF, deactivates the **START** key on the instrument front panel. Programs can only be started from the instrument relay board.

Miscellaneous:

- Smart key, to configure the assigned to the "SMART KEY" key.
- Auto setup, to enables the automatic creation of a simple test program.

3. SERVICE MENU MAINTENANCE

Reset parameters: to perform a complete reset of the tests parameters (reset to factory configuration).

CAN status: state of the internal network of the device.

Valve counter: to give an approximate state of the valves wear.

Device info: to know the information about the device, program version, built in components etc.

Special cycles: to enable the user to adjust the pressures and service the valves and pressure sensors. To make appear these special cycles in the special cycle menu, this function must be activated.

4. RESULTS MENU

Results menu: to manage the test results.

- Save on, to select the results saving mode, "**NONE**" = no save, "**INTERNAL**" to save the results in the internal memory and "**USB**" to save the results in the USB memory key connected to the device (in this mode, if no memory key is connected, the results are lost).
- Last results, to display the 6 lasts results carried out by the device and possibly to delete them.
- Statistics, to display the results statistics by program.

5. USB MENU

This is to save on an USB memory key the parameters to recover for later use, device cloning, and program cloning or backup for device reconfiguration.

This is running if the parameters are unlocked.

ACCESSORIES AND CHARACTERISTICS

1. ACCESSORIES PROVIDED

1.1. 100 TO 230 V AC POWER SUPPLY



The power supply cable of the **F670** allows its connection to the mains supply network (from 100 to 240V AC).

2. ACCESSORIES IN OPTION

Master leaks: the master leaks are used to check the device calibration.

Micrometer valve and **Leak Calibrator** (CDF).

Automatic connectors with expandable seals

Filtration kit.

Singles **remote controls**.

3. TECHNICAL CHARACTERISTIC OF THE F670

Case dimensions H x L x D (mm):	157x 537 x 305
Overall dimensions (mm):	157x 537 x 380
Electric power supply:	100 à 240 V AC / 2 A
Pneumatics connections:	3/5, 4/6 or 6/8
Weight (kg):	about 8
Format :	19 inches (3U)
Running temperature:	+10°C to +45°C
Storage temperature:	0°C to +60 °C

ERRORS AND FAULTS

1. ERROR MESSAGES

The **ATEQ F670** can display error messages if there are operational problems.

- **Reference** fault.
- **Test** fault.
- Pressure in excess of the **full scale**.
- Error on the **differential sensor**.
- Pressure in **excess of the max. threshold**.
- Pressure **below the min. threshold**.
- **ATR** fault.
- Fault or drift **CAL**.
- **Valve commutation** fault.
- **PROG Error**.
- **Inappropriate size** for the selected unit of pressure.
- **Sealed component** learning error.
- **Sealed component** error.
- **Sealed components** large leak error.
- **Auto-test** fault.

2. IN CASE OF OPERATION DOUBT

If a test machine begins to detect too many fail parts (more than three consecutively), it is advisable to carry out a **check on the whole unit**. The quality of the manufacture and operation of the leak detector should be the last things considered.

There is a possibility that the seals may be cut by shavings or worn by repetitive squashing. This can be prevented by regular servicing and replacement of the seals.

If all the other checks do not resolve the problem, the instrument's circuit may be checked.

ATEQ does not accept any liability in regard to calibrations and settings to its instruments which are not carried out by its own personnel.

INDEX

A		P	
Accessories	22	Pneumatic supply	10
Additional functions	18	Pneumatics connectors	11
Automatics connectors	11	Pneumatics outputs	11
C		Pressure unit.....	16
Characteristics	22	Program creation	15
Cycle keys	11	Programme courant.....	17
D		Programs edition.....	17
Definition.....	2	Q	
Display.....	12	Quick connector	11
Display results	21	R	
Dump time	16	Reference reject	16
E		Reject unit.....	16
Electrics connectors	5	Reset results.....	21
Error Messages	24	Results menu.....	21
F		S	
Fail operation.....	24	Service menu.....	21
Fill instruction.....	16	Service special cycles.....	21
Fill time	16	Smart key	13
Functions	16, 18	Special cycles	19
I		Stabilization time.....	16
Installation	4	Start cycle	17
L		Starting up	14
Language.....	20	Stop cycle	17
M		T	
Main menu.....	14	Test menu.....	15
Main types of measurements.....	3	Test parameters.....	16
Maximum fill.....	16	Test Reject	16
Measurement cycle	3	Test time	16
Measurements characteristics	2	Touches de cycle.....	12
Minimum fill.....	16	Type of test.....	3
More functions menu	18	U	
N		USB	5
Navigation.....	11		
Navigation keys	12		
O			
Operation fault.....	24		

